

**TESTING FOR THE VERIFICATION OF COMPLIANCE OF
PV INVERTER WITH :
AS / NZS 4777.2:2015 GRID CONNECTION OF ENERGY
SYSTEMS VIA INVERTERS
(PART 2: INVERTER REQUIREMENTS)**

Procedure: PE.T-LE-62

Test Report Number: 2219-0185-H

Trademark.....: 

Tested Model: SOFAR 3300TL-G3

Variant Models: SOFAR 3000TL-G3, SOFAR 2700TL-G3
SOFAR 2200TL-G3, SOFAR 1600TL-G3, SOFAR 1100TL-G3

APPLICANT

Name: Shenzhen SOFAR SOLAR Co., Ltd.

Address.....: 401, Building 4, AnTongDa Industrial Park, District 68,
XingDong Community, XinAn Street, BaoAn District, Shenzhen
City, Guangdong Province, P.R. China

TESTING LABORATORY

Name: SGS Tecnos, S.A. (Electrical Testing Laboratory)

Address.....: C/ Trespaderne, 29 - Edificio Barajas 1
28042 MADRID (Spain)

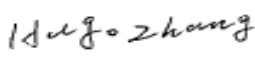
Conducted (tested) by: Hugo Zhang 
(Project Engineer)

Roger Hu 
(Project Engineer)

Approved by: Jacobo Tevar
(Technical Reviewer)

Date of issue: 14/02/2020

Number of pages: 127

Important Note:

- This document is issued by the Company under its General Conditions of service accessible at http://www.sgs.com/terms_and_conditions.htm. Attention is drawn to the limitation of liability, indemnification and jurisdiction issues defined therein. Any holder of this document is advised that information contained hereon reflects the Company's findings at the time of its intervention only and within the limits of Client's instructions, if any. The Company's sole responsibility is to its Client and this document does not exonerate parties to a transaction from exercising all their rights and obligations under the transaction documents.
- Any unauthorized alteration, forgery or falsification of the content or appearance of this document is unlawful and offenders may be prosecuted to the fullest extent of the law.
- Unless otherwise stated the results shown in this test report refer only to the sample(s) tested as received. **Information of derived or extension models of the range as provided by the applicant, (if any), is included in this report only for informative purposes.** The Company SGS shall not be liable for any incorrect results arising from unclear, erroneous, incomplete, misleading or false information provided by Client. This document cannot be reproduced except in full, without prior approval of the Company.

Test Report Historical Revision:

Test Report Version	Date	Resume
2219-0185-H	14/02/2020	First issuance

INDEX

1	SCOPE.....	5
2	GENERAL INFORMATION	6
2.1	Testing Period and Climatic conditions	6
2.2	Equipment under Testing	6
2.3	Manufacturer and Factory information	9
2.4	Test equipment list	10
2.5	Measurement uncertainty	10
2.6	Test set up of the different standard	11
2.7	Definitions	12
3	RESUME OF TEST RESULTS	13
4	TEST RESULTS	15
4.1	Reference Network Impedance	15
4.2	Electrical Safety	15
4.3	Provision for External Connections.....	15
4.4	PV Array earth fault / earth leakage detection.....	15
4.5	Compatibility with Electrical Installation	16
4.6	Power Factor.....	19
4.7	Voltage quality measurements	21
4.7.1	Current harmonics	21
4.7.2	Voltage harmonics	24
4.8	Flickers in continuous operation	27
4.9	Transient Voltage Limits.....	29
4.10	D.C. current injection	32
4.11	Current Balance for Three – Phase Inverters.....	33
4.12	Operational Modes and Multiple Mode Inverters.....	33
4.12.1	Inverter Demand Response Modes (DRMs)	33
4.12.2	Test for standard operation of generator demand response modes	36
4.12.3	Interaction with demand response enabling device (DRED).....	37
4.13	Inverter Power Quality Response Modes.....	37
4.13.1	Volt Response Modes	37
4.13.2	Fixed Power Factor Mode and Reactive Power Mode.....	45
4.13.3	Characteristics Power Factor Curve for Cos ϕ (Power Response).....	52
4.13.4.1	Power rate limit	59
4.13.4.2	Changes in a.c. operation and control.....	61
4.13.4.3	Changes in energy source operation	61
4.14	Multiple mode inverter operation	62
4.14.1	Sinusoidal output in stand-alone mode	62
4.14.2	Volt–watt response mode for charging of energy storage.....	62
4.15	Security of operational settings.....	63
4.16	Automatic Disconnection Device	63
4.17	Active Anti-Islanding protection	63
4.17.1	Test A	64
4.17.2	Test B	65
4.17.3	Test C	66
4.18	Voltage and Frequency Limits (Passive Anti-Islanding Protection)	67
4.18.1	Voltage trip tests	68
4.18.2	Frequency trip tests.....	81
4.19	Sustained Operation for Voltage Variations	89
4.19.1	Voltage trip value tests	89
4.19.2	Trip time test.....	94
4.20	Sustained Operation for Frequency Variations.....	96
4.20.1	Response to an increase in frequency.....	96
4.20.2	Response to a decrease in grid frequency.....	103
4.21	Disconnection on external signal.....	103
4.22	Connection and Reconnection Procedure.....	103

4.22.1	Frequency Connection	103
4.22.2	Frequency Reconnection	106
4.22.3	Voltage Connection.....	108
4.22.4	Voltage Reconnection	110
4.23	Security of Protection Settings.....	112
4.24	Multiple Inverter Combination.....	112
4.25	Inverter Marking and Documentation.....	112
5	PICTURES	117
6	ELECTRICAL SCHEMES.....	127

1 SCOPE

SGS Tecnos, S.A. (Electrical Testing Laboratory) has been contract by Shenzhen SOFAR SOLAR Co., Ltd., in order to perform the testing according to the AS/NZS 4777.2: 2015: Grid connection of energy systems via inverters. Part 2: Inverter requirements.

For the purpose of this test report, it is to be used for the certification for Australia only, but further tests having settings for New Zealand have just been included for information purposes.

2 GENERAL INFORMATION

2.1 Testing Period and Climatic conditions

The necessary testing has been performed along 15 working days between the 30th of September of 2019 and the 11th of January of 2020.

All the tests and checks have been performed at 25 °C ± 5 °C, 96 kPa ± 10 kPa and 40% RH ± 10% RH.

SITE TEST

Name..... : Shenzhen SOFAR SOLAR Co., Ltd.
 Address : 401, Building 4, AnTongDa Industrial Park, District 68,
 XingDong Community, XinAn Street, BaoAn District,
 Shenzhen City, Guangdong Province, P.R. China

2.2 Equipment under Testing



Apparatus type : Solar Grid-tied Inverter
 Installation : Fixed (permanent connection)
 Manufacturer : Shenzhen SOFAR SOLAR Co., Ltd.
 Trade mark : 
 Model / Type reference : SOFAR 3300TL-G3
 Serial Number..... : SA3ES133K5K004
 Software Version : V1.00
 Rated Characteristics..... : DC input: 50-550 V, Max.12 A
 AC output: 230 Vac, 50 Hz, 14.3 A (Max. 16 A), 3300 VA.

Date of manufacturing: 2019

Test item particulars

Input : PV
 Output : AC
 Class of protection against electric shock... : Class I
 Degree of protection against moisture..... : IP 65
 Type of connection to the main supply : Single phase – Fixed installation
 Cooling group : Heat sink
 Modular : No
 Internal Transformer : No

Copy of rating plate (representative):

 Solar Grid-tied Inverter	
Model No.	SOFAR 3300TL-G3
Max.DC Input Voltage	550V
Operating MPPT Voltage Range	50~550V
Max. Input Current	12A
Max. PV Isc	15A
Nominal Grid Voltage	L/N/PE,230Vac
Max. Output Current	16A
Nominal Grid Frequency	50/60Hz
Max. Output Power	3300VA
Power Factor	1(adjustable+/-0.8)
Ingress protection	IP65
Operating Temperature Range	-30~+60°C
Topology	Non-isolated
Protective Class	Class I
Manufacturer:Shenzhen SOFARSOLAR Co., Ltd. Address: 401, Building 4, AnTongDa Industrial Park,District 68, XingDong Community, XinAn Street,BaoAn District, Shenzhen, China VDE0126-1-1,VDE-AR-N4105, IEC61727, IEC62116, UTE C15-712-1,AS4777	
	

Note:

1. The above markings are the minimum requirements required by the safety standard. For the final production samples, the additional markings which do not give rise to misunderstanding may be added.
2. Label is attached on the side surface of enclosure and visible after installation.
3. Labels of other models are as the same with SOFAR 3300TL-G3's except the parameters of rating.

Equipment under testing:

- SOFAR 3300TL-G3

The variants models are:

- SOFAR 3000TL-G3
- SOFAR 2700TL-G3
- SOFAR 2200TL-G3
- SOFAR 1600TL-G3
- SOFAR 1100TL-G3

Model Number	SOFAR 3300TL-G3	SOFAR 3000TL-G3	SOFAR 2700TL-G3	SOFAR 2200TL-G3	SOFAR 1600TL-G3	SOFAR 1100TL-G3
Max. input voltage	550Vd.c.			500Vd.c.		
Max. input current	12 Ad.c.	12 Ad.c.	12 Ad.c.	12 Ad.c.	12 Ad.c.	12 Ad.c.
Operating MPPT voltage range	50-550Vd.c.			50-500Vd.c.		
Full load DC Voltage Range	300-500 Vd.c.	275-500 Vd.c.	250-500 Vd.c.	200-450 Vd.c.	150-450 Vd.c.	110-450 Vd.c.
Rated voltage	360 V					
Rated grid voltage	230 Va.c.					
Rated grid frequency	50 Hz					
Rated output power	3.3 kW	3.0 kW	2.7 kW	2.2 kW	1.6 kW	1.1 kW
Rated output current	14.3 Aa.c.	13 Aa.c.	11.8 Aa.c.	9.6 Aa.c.	7 Aa.c.	4.8 Aa.c.
Max. Output Current	16 Aa.c.	14.5 Aa.c.	13 Aa.c.	10.6 Aa.c.	7.7 Aa.c.	5.3 Aa.c.
Power factor	0.8 leading to 0.8 lagging					
Ambient temperature	-30 °C ~ 60 °C					
Ingress protection	IP65					
Protective class	Class I					

The variants models have been included in this test report without tests because the following features don't change regarding to the tested model:

- Same connection system and hardware topology.
- Same control algorithm.
- Same Firmware Version.

The results obtained apply only to the particular sample tested that is the subject of the present test report. The most unfavorable result values of the verifications and tests performed are contained herein.

Throughout this report a point (comma) is used as the decimal separator.

2.3 Manufacturer and Factory information

Manufacturer Name.....: Shenzhen SOFAR SOLAR Co., Ltd.

Manufacturer Address: 401, Building 4, AnTongDa Industrial Park,
District 68, XingDong Community, XinAn Street,
BaoAn District, Shenzhen City, Guangdong
Province, P.R. China

Factory Name: Dongguan SOFAR SOLAR Co., Ltd.

Factory Address: 1F - 6F, Building E, No. 1 JinQi Road, Bihu
Industrial Park, Wulian Village, Fenggang Town,
Dongguan City, Guangdong Province, P.R. China.

2.4 Test equipment list

From	No.	Equipment Name	Model No.	Equipment No.	Calibration Date	Equipment calibration due date
Sofar Solar	1	Digital oscilloscope	Keysight / DS05014A	MY50070266	2019-02-13	2020-02-12
	2	Voltage probe	SanHua / SI-9110	111541	2019-02-13	2020-02-12
	3	Voltage probe	SanHua / SI-9110	152627	2019-02-13	2020-02-12
	4	Voltage probe	SanHua / SI-9110	111134	2019-02-13	2020-02-12
	5	Power analyzer	Yokogawa / WT3000	91N610888	2019-02-13	2020-02-12
	6	Current probe	Fluke / i1000s	29503223	2019-02-13	2020-02-12
	7	Current probe	Fluke / i1000s	30413448	2019-02-13	2020-02-12
	8	Current probe	CA / CP5150	C150150008	2019-02-13	2020-02-12
	9	Temperature & Humidity meter	Anymeters / TH101B	201030245220	2019-02-13	2020-02-12
SGS	10	True RMS Multimeter	Fluke / 289C	GZE012-53	2019-02-26	2020-02-25

2.5 Measurement uncertainty

Associated uncertainties through measurements showed in this this report are the maximum allowable uncertainties.

Magnitude	Uncertainty
Voltage measurement	±1.5 %
Current measurement	±2.0 %
Frequency measurement	±0.2 %
Time measurement	±0.2 %
Power measurement	±2.5 %
Phase Angle	±1°
Temperature	±3 °C
<p>Note1: Measurements uncertainties showed in this table are maximum allowable uncertainties. The measurement uncertainties associated with other parameters measured during the tests are in the laboratory at disposal of the solicitant.</p> <p>Note2: Where the standard requires lower uncertainties that those in this table. Most restrictive uncertainty has been considered.</p>	

2.6 Test set up of the different standard

Below is the simplified construction of the test set up.

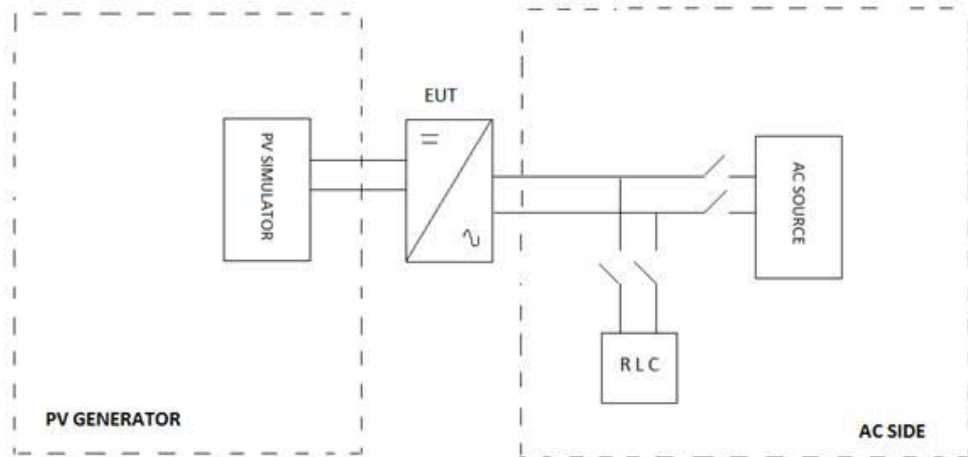

Different equipment has been used to take measures as shown in chapter 2.3. Current and voltage clamps have been connected to the inverter input/output for all the tests.

All the tests described in the following pages have used this specified test setup.

The test bench used includes:

EQUIPMENT	MARK / MODEL	RATED CHARACTERISTICS	OWNER / ID.CODE
AC source	Kwell / AFG-S-33800	Voltage: 0-600 V 750 kVA	Sofar solar / EP-026
PV source	Kwell / TVS-630kW	Voltage: 0-1000 V 630 kW	Sofar solar / EP-027

2.7 Definitions

EUT	Equipment Under Testing	Hz	Hertz
A	Ampere	V	Volt
VAr	Volt-Ampere reactive	W	Watt
Un	Nominal Voltage	In	Nominal current
Pn	Nominal Active Power	Sn	Nominal Apparent Power
Qn	Nominal Reactive Power	p.u	Per unit
V1+	Voltage Positive Sequence	I1+	Current Positive Sequence
V1-	Voltage Negative Sequence	I1-	Current Negative Sequence
Uv	Voltage Imbalance	Ui	Current Imbalance
DRM	Demand Response Mode	THD	Total Harmonic Distortion
I _h	Harmonic Current	U _h	Harmonic Voltage
PST	Severity of Flicker Short-Term	PLT	Severity of Flicker Long-Term
dc	Maximum Variation of Voltage	d(t)	Variation of Voltage
DRED	Demand Response Enabling Device	d max	Maximum Absolute Value of Voltage Variation

3 RESUME OF TEST RESULTS

INTERPRETATION KEYS

- Test object does meet the requirement : **P** Pass
- Test object does not meet the requirement : **F** Fails
- Test case does not apply to the test object : **N/A** Not applicable
- To make a reference to a table or an annex..... : See additional sheet
- To indicate that the test has not been realized : **N/R** Not realized

STANDARD SECTION	STANDARD REQUIREMENTS	RESULT
	AS/NZS 4777.2:2015	
A.5	Reference network impedance	P
	Network impedance	P
5	General Requirements	P
5.1	Electrical safety	N/R
5.2	Provision for External Connections	P
5.3	PV Array earth fault/earth leakage detection	N/R
5.4	Compatibility with electrical installation	P
5.5	Power Factor	P
5.6	Harmonics	--
--	Harmonics Current	P
--	Harmonics Voltage	P
5.7	Flickers	P
5.8	Transient voltage limits	P
5.9	DC Current Injection	P
5.10	Current Balance for Three-phase inverters	N/A
6	Operational modes and Multiple mode inverters	P
6.2	Inverter Demand Response Modes (DRMs)	P
6.2.1	General	P
6.2.2	Interaction with Demand Response Enabling Device (DRED)	P
6.3	Inverter Power quality response modes	P
6.3.2	Volt response modes	P
6.3.2.2	Volt-Watt response mode	P
6.3.2.3	Volt-Var response mode	P
6.3.2.4	Voltage balanced modes	N/A
6.3.3	Fixed power factor mode and reactive power mode	P
6.3.4	Characteristic power factor curve for $\cos \phi$ (P) (Power response)	P
6.3.5	Power rate limit	P
6.3.5.3.3	Changes in a.c. operation and control	N/A
6.3.5.3.4	Changes in energy source operation	N/A
6.4	Multiple mode inverter operation	N/A
6.4.2	Sinusoidal output in stand-alone mode (Harmonics voltage)	N/A
6.4.3	Volt-Watt response mode for charging of energy storage	N/A
6.5	Security	P
7	Protective functions for connection to electrical installations and the grid	P
7.2	Automatic disconnection device	P
7.3	Active Anti-Islanding protection	P
7.4	Voltage and frequency limits (passive anti-islanding protection)	P
7.5	Limits for sustained operation	P

STANDARD SECTION	STANDARD REQUIREMENTS	RESULT
	AS/NZS 4777.2:2015	
7.5.2	Sustained operation for voltage variations	P
7.5.3	Sustained operation for frequency variations	P
7.5.3.1	Response to an increase in frequency	P
--	Response to a decrease in frequency	P
7.5.3.2	Response to a decrease in grid frequency with energy storage	N/A
7.6	Disconnection on external signal	P
7.7	Connection and reconnection procedure	P
7.8	Security of protection settings	P
8	Multiple inverter combination	N/A
8.2	Inverter current balance across multiple phases	N/A
8.3	Grid Disconnection	N/A
8.4	Grid Connection and Reconnection	N/A
8.5.1	Single-phase combinations	N/A
8.5.2	Single-phase inverters used in three-phase combinations	N/A
8.5.3	Required Tests for Multiple Inverter Combinations	N/A
8.5.4	Multiple Inverters with one Automatic Disconnection Device	N/A
9	Inverter marking and documentation	P

Note: The declaration of conformity has been evaluated taking into account the IEC Guide 115.

4 TEST RESULTS

4.1 REFERENCE NETWORK IMPEDANCE

The network reference impedance used during the tests has been of:

$R_A = 0.24$ Ohms; $X_A = j 0.15$ Ohms at 50 Hz;
 $R_N = 0.16$ Ohms; $X_N = j 0.10$ Ohms at 50 Hz.

4.2 ELECTRICAL SAFETY

As required per the Clause 5.1 of the standard, inverters for use in energy systems with photovoltaic (PV) arrays, the inverters shall comply with the appropriate electrical safety requirements. The compliances with these requirements are stated in the following test reports:

- IEC 62109-1 and IEC 62109-2: test report n° BL-SZ1930601-B01 on Apr.10, 2019 which issued by Shenzhen BALUN Technology Co., Ltd.

4.3 PROVISION FOR EXTERNAL CONNECTIONS

The inverter complies with the requirements according to Clause 5.2 of the standard.

4.4 PV ARRAY EARTH FAULT / EARTH LEAKAGE DETECTION

The compliances with these requirements are stated in the following test reports:

- IEC 62109-1 and IEC 62109-2: test report n° BL-SZ1930601-B01 on Apr.10, 2019 which issued by Shenzhen BALUN Technology Co., Ltd.

4.5 COMPATIBILITY WITH ELECTRICAL INSTALLATION

According to the requirements stated in the clause 5.4 of the standard, it has been verified that the inverter is able to operate with AC voltage and frequency limits specified in AS 60038 (for Australia).

The inverter shall stay connected providing the maximum of its available active power working in abnormal voltage and/or frequency conditions.

The following tables show the results of the tests performed:

Test 1		Under Frequency		
Voltage	Frequency	Active Power measured	Minimum Operation Time	Time measured
100 %Un	47.1 Hz	100.2 %Pn	Continuous Operation	> 5 min
Disconnection		<input checked="" type="checkbox"/> NO <input type="checkbox"/> YES		

Test 2		Under Voltage		
Voltage	Frequency	Active Power measured	Minimum Operation Time	Time measured
94 %Un	50.0 Hz	100.3 %Pn	Continuous Operation	> 5 min
Disconnection		<input checked="" type="checkbox"/> NO <input type="checkbox"/> YES		

Test 3		Over Voltage + Over Frequency		
Voltage	Frequency	Active Power measured	Minimum Operation Time	Time measured
110 %Un	50.25 Hz	100.2 %Pn	Continuous Operation	> 5 min
Disconnection		<input checked="" type="checkbox"/> NO <input type="checkbox"/> YES		

(*) The measured value of active power is calculated as the average of the samples taken each 100 ms during the corresponding measured time.

Test 1 (V = 100 %Un and f = 47.1 Hz)

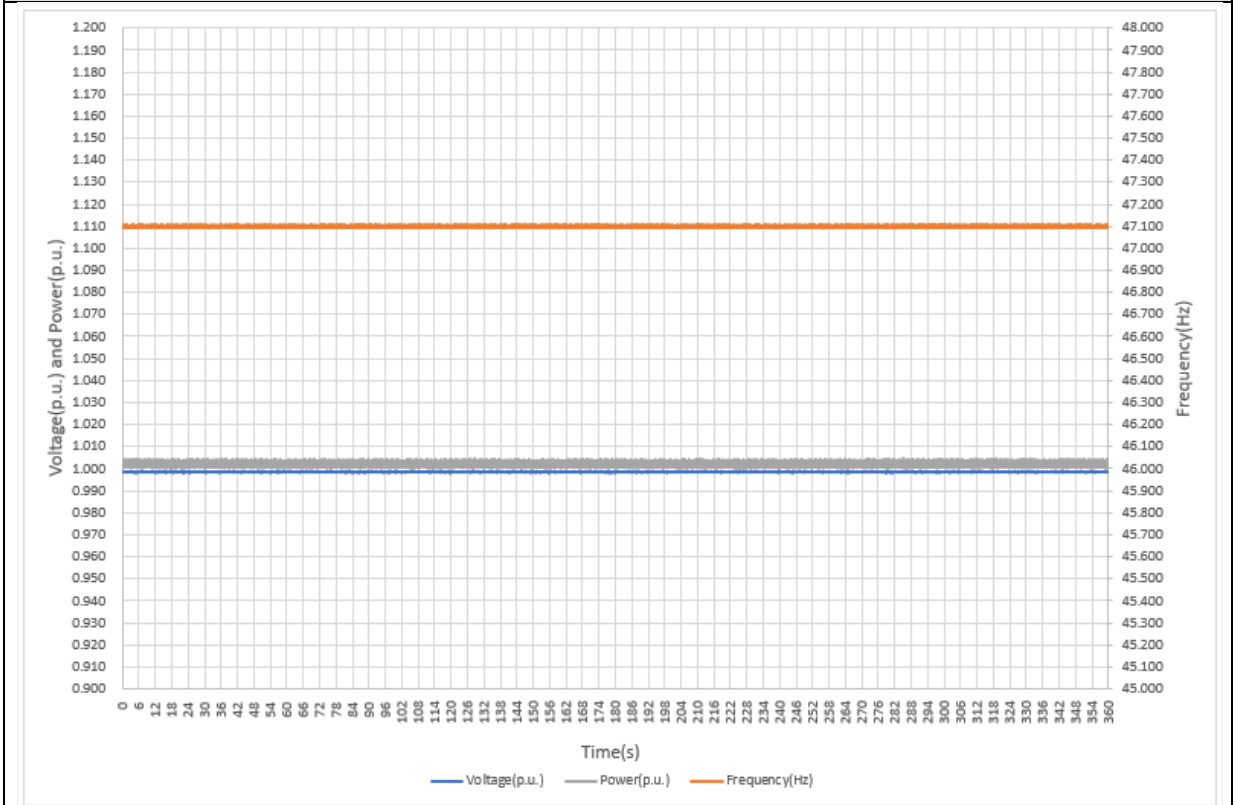

Time measured: 6 min

Voltage average measured: 99.9 %Un

Frequency measured: 47.10 Hz

Test 2 (V = 94 %Un and f = 50.0 Hz)

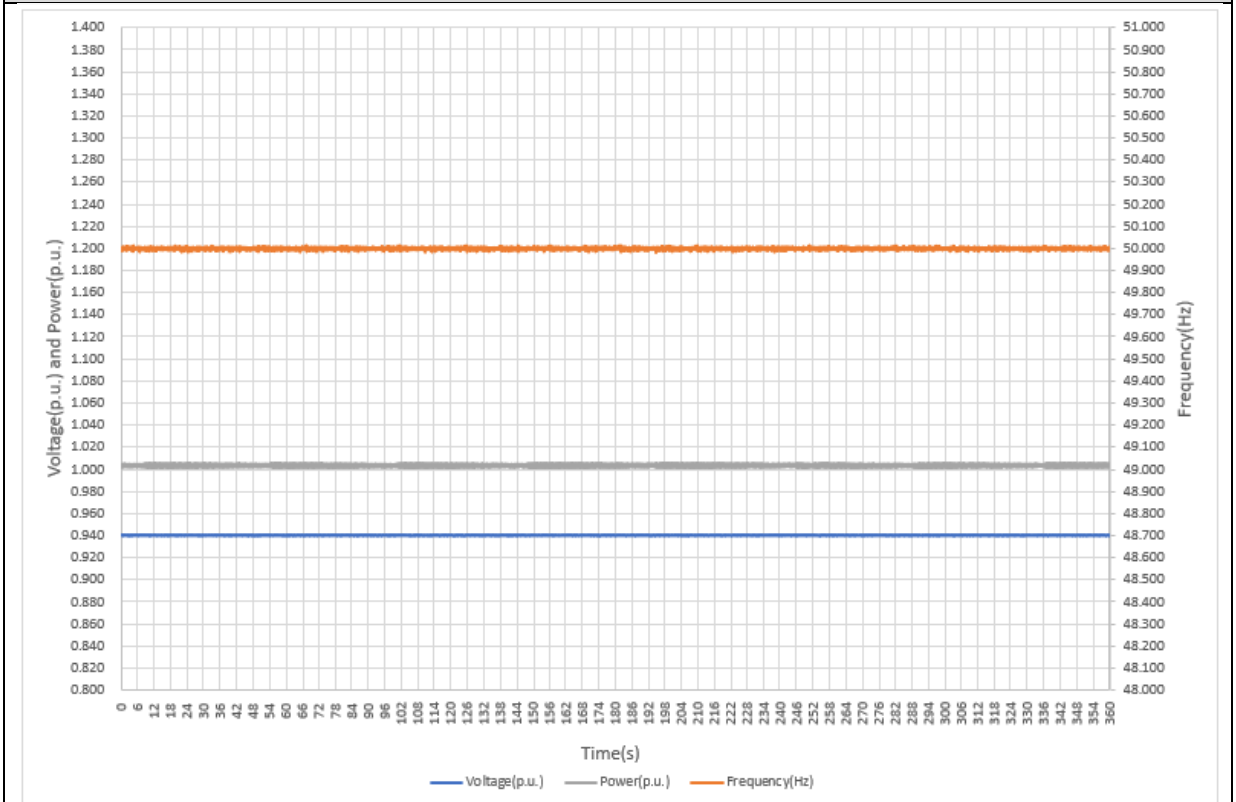

Time measured: 6 min

Voltage average measured: 94.0 %Un

Frequency measured: 50.00 Hz

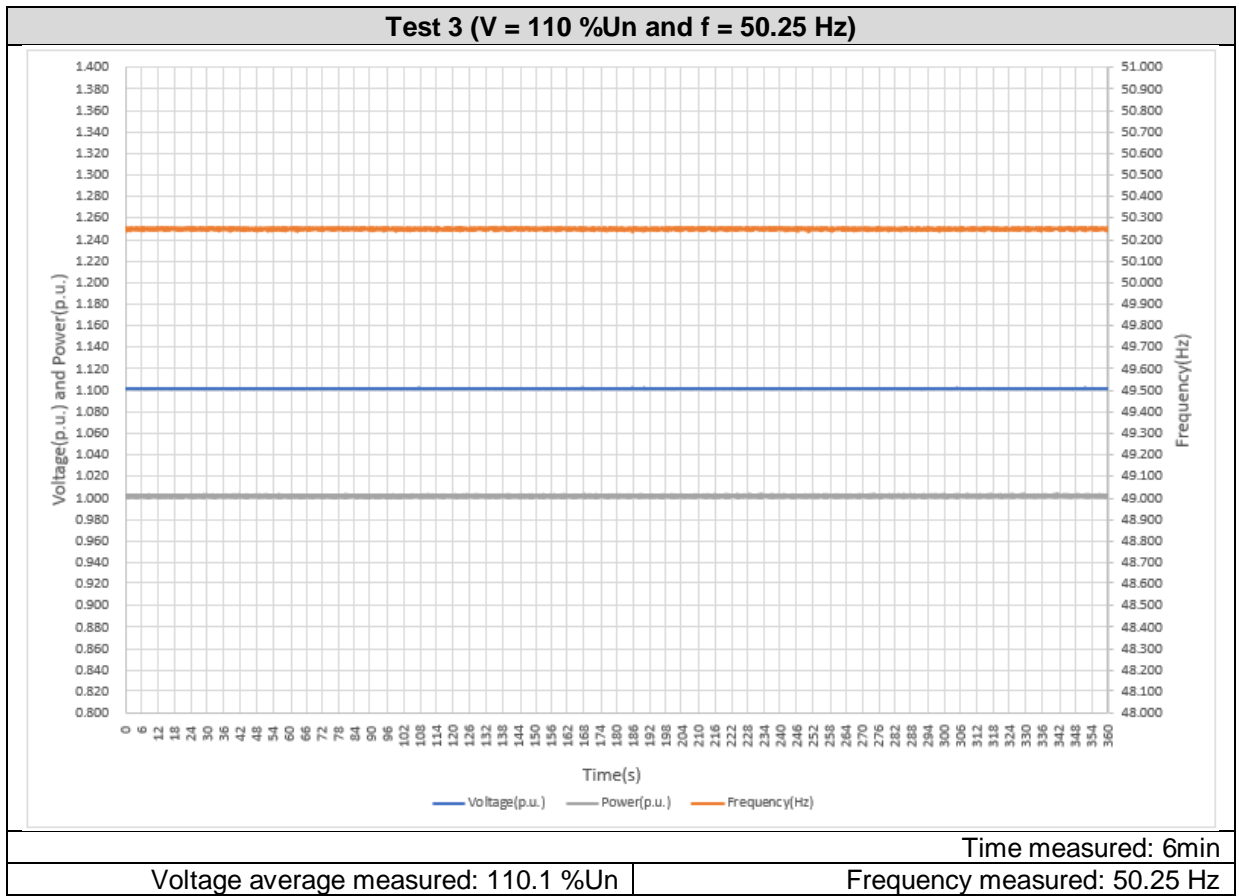

4.6 POWER FACTOR

The power factor has been measured according to Clause 5.5 and the annex B of the standard, with an initial power factor at unity.

For power factor capabilities check point 4.13.2.2 of the report where the test has been repeated using 0.8 leading to 0.8 lagging which is more restrictive than 0.95 as the standard required.

The maximum tolerance allowed for the measured Power Factor is ± 0.01 , for measurements from 25 %Sn.

The following table and graphs show test results for measurements of power factor set to unity (PF=1):

Unity Power Factor (PF=1.0)					
P Desired (%Sn)	P measured (%Sn)	Q measured (%Sn)	Power Factor desired (cos ϕ)	Power Factor measured (cos ϕ)	Power Factor Deviation (cos ϕ)
5	5.0	1.5	1.000	0.956	-0.044
15	15.6	1.4	1.000	0.996	-0.004
25	26.2	1.6	1.000	0.998	-0.002
35	36.9	1.8	1.000	0.999	-0.001
50	47.1	2.0	1.000	0.999	-0.001
55	57.3	2.3	1.000	0.999	-0.001
65	67.5	2.7	1.000	0.999	-0.001
75	77.6	2.7	1.000	0.999	-0.001
85	87.7	2.5	1.000	0.999	-0.001
95	97.7	2.8	1.000	0.999	-0.001
100	100.5	2.5	1.000	0.999	-0.001

Unity Power Factor (PF=1.0)

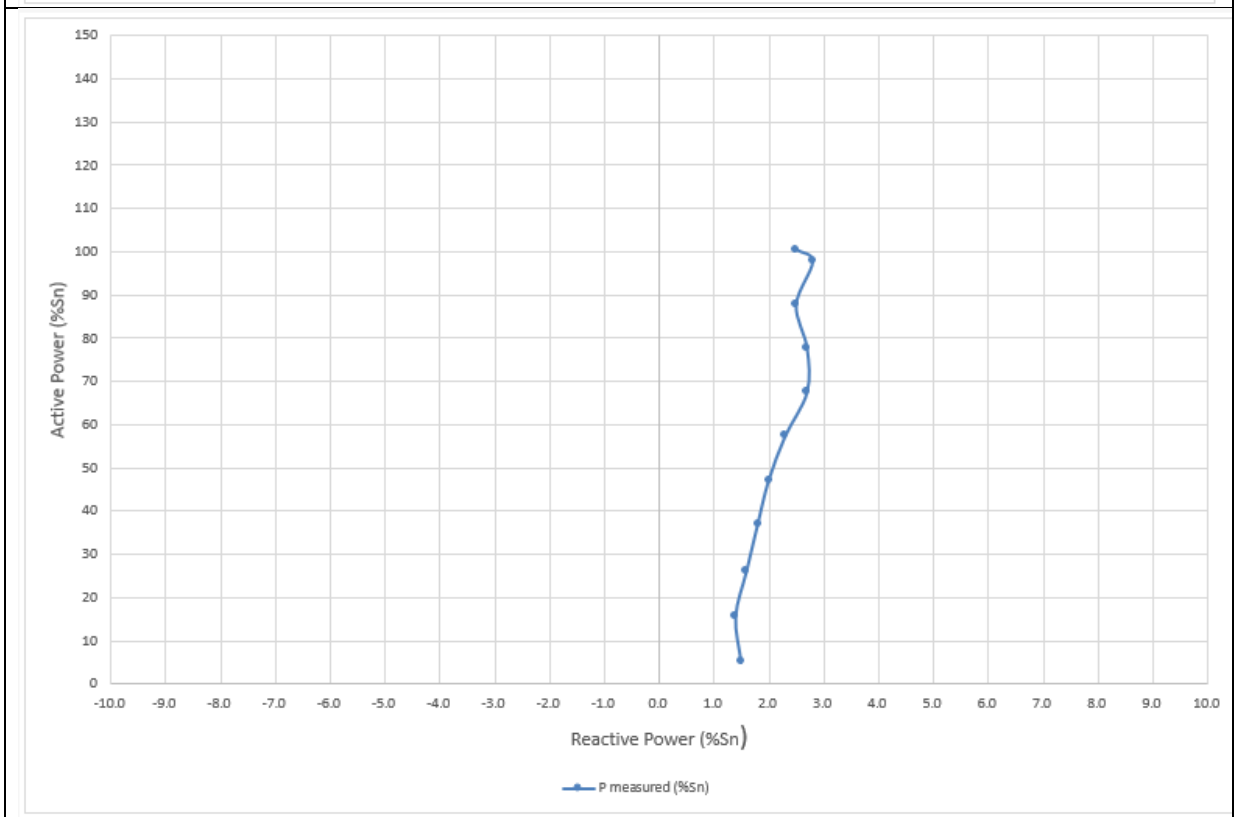
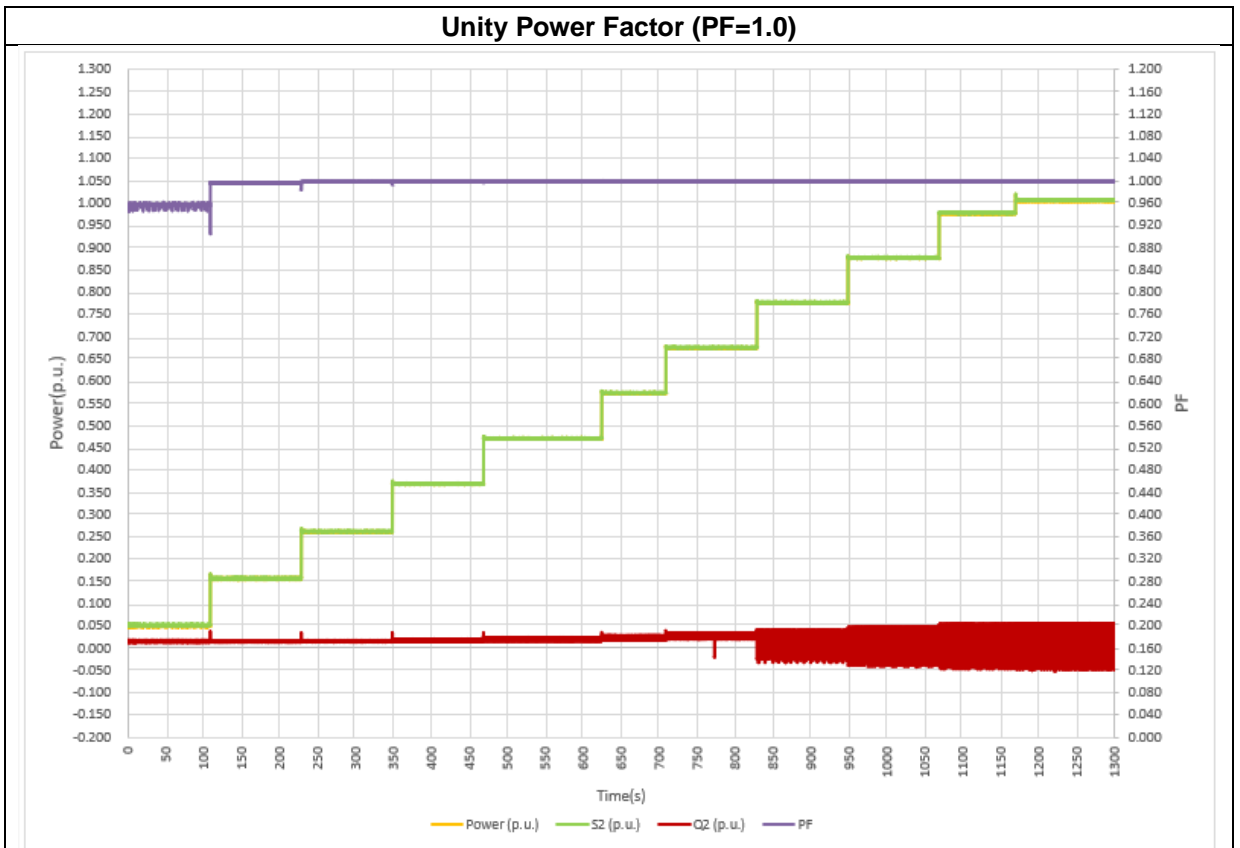

4.7 VOLTAGE QUALITY MEASUREMENTS

4.7.1 Current harmonics

The current harmonics have been measured according to the Clause 5.6 of the standard, at the required power values.

	Limit	50% of rated current	100% of rated current
Eliminate order	% of fundamental	% of fundamental	% of fundamental
2	1.000	0.051	0.044
3	4.000	0.426	1.168
4	1.000	0.105	0.084
5	4.000	0.068	0.615
6	1.000	0.081	0.044
7	4.000	0.043	0.378
8	1.000	0.051	0.022
9	2.000	0.063	0.330
10	0.500	0.043	0.038
11	2.000	0.074	0.150
12	0.500	0.029	0.012
13	2.000	0.095	0.078
14	0.500	0.013	0.010
15	1.000	0.096	0.078
16	0.500	0.037	0.020
17	1.000	0.092	0.124
18	0.500	0.060	0.032
19	1.000	0.086	0.073
20	0.500	0.015	0.012
21	0.600	0.084	0.030
22	0.500	0.024	0.014
23	0.600	0.066	0.036
24	0.500	0.030	0.027
25	0.600	0.076	0.043
26	0.500	0.014	0.013
27	0.600	0.074	0.038
28	0.500	0.030	0.008
29	0.600	0.079	0.041
30	0.500	0.019	0.009
31	0.600	0.078	0.035
32	0.500	0.012	0.006
33	0.600	0.079	0.029
34	--	0.016	0.010
35	--	0.077	0.038
36	--	0.017	0.007
37	--	0.075	0.040
38	--	0.015	0.011
39	--	0.067	0.037
40	--	0.013	0.008

	Limit	50% of rated current	100% of rated current
Eliminate order	% of fundamental	% of fundamental	% of fundamental
41	--	0.062	0.032
42	--	0.011	0.007
43	--	0.053	0.035
44	--	0.010	0.005
45	--	0.051	0.034
46	--	0.010	0.005
47	--	0.044	0.033
48	--	0.010	0.006
49	--	0.041	0.035
50	--	0.023	0.013
THD		0.581	1.444

Current Harmonics

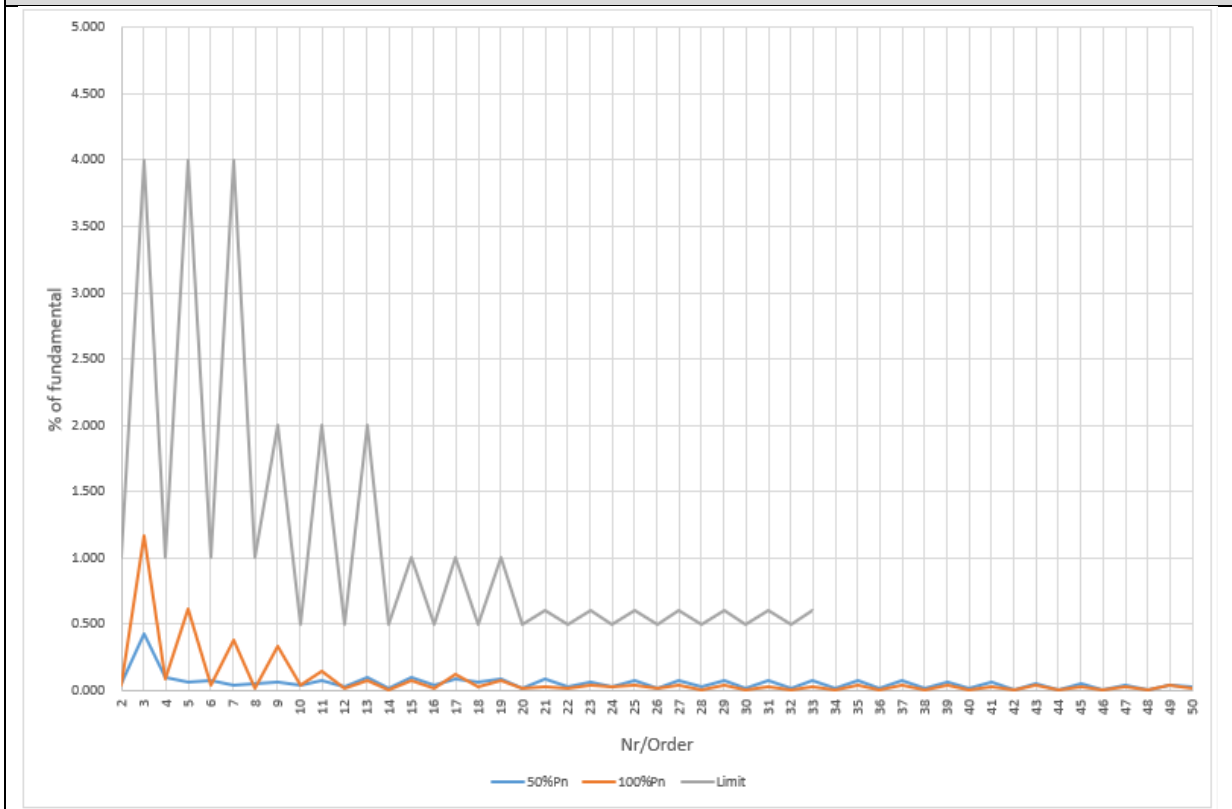

THD

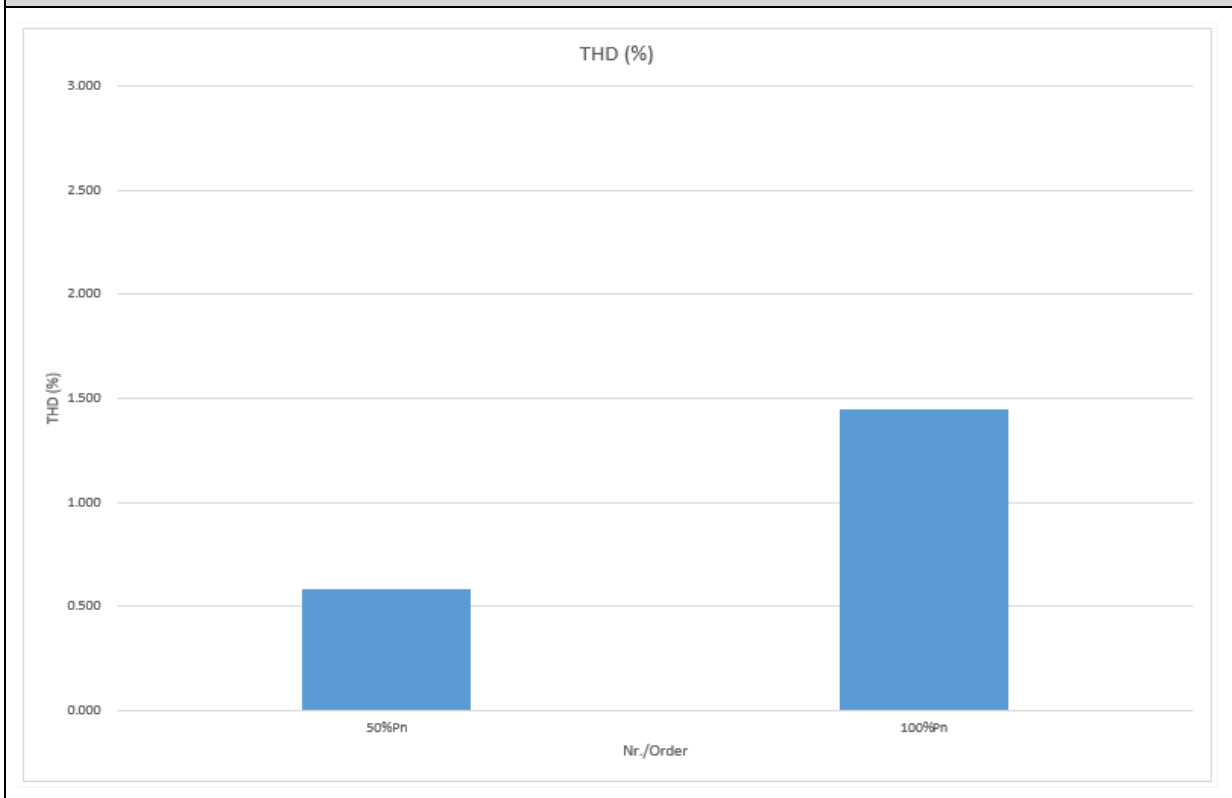

4.7.2 Voltage harmonics

The background voltage harmonics have been verified according to the Clause 5.6 (Appendix C) of the standard, into AC terminals of the grid source.

The test results are shown in the graphic and the table below.

Voltage Source Harmonics		
Nr/Order	Limit U_h (%fundamental)	Measured U_h (%fundamental)
2	0.200	0.005
3	0.900	0.148
4	0.200	0.005
5	0.400	0.024
6	0.200	0.005
7	0.300	0.012
8	0.200	0.005
9	0.200	0.006
10	0.200	0.003
11	0.100	0.012
12	0.100	0.001
13	0.100	0.014
14	0.100	0.002
15	0.100	0.010
16	0.100	0.003
17	0.100	0.008
18	0.100	0.004
19	0.100	0.005
20	0.100	0.003
21	0.100	0.003
22	0.100	0.002
23	0.100	0.003
24	0.100	0.001
25	0.100	0.005
26	0.100	0.001
27	0.100	0.007
28	0.100	0.002
29	0.100	0.005
30	0.100	0.002
31	0.100	0.004
32	0.100	0.002
33	0.100	0.002
34	0.100	0.001
35	0.100	0.005
36	0.100	0.003
37	0.100	0.007
38	0.100	0.001
39	0.100	0.005
40	0.100	0.001
41	0.100	0.008

Voltage Source Harmonics		
Nr/Order	Limit U_h (%fundamental)	Measured U_h (%fundamental)
42	0.100	0.001
43	0.100	0.005
44	0.100	0.001
45	0.100	0.004
46	0.100	0.001
47	0.100	0.003
48	0.100	0.001
49	0.100	0.003
50	0.100	0.002
THD(%fundamental)	5.000	0.154

Voltage Source Harmonics

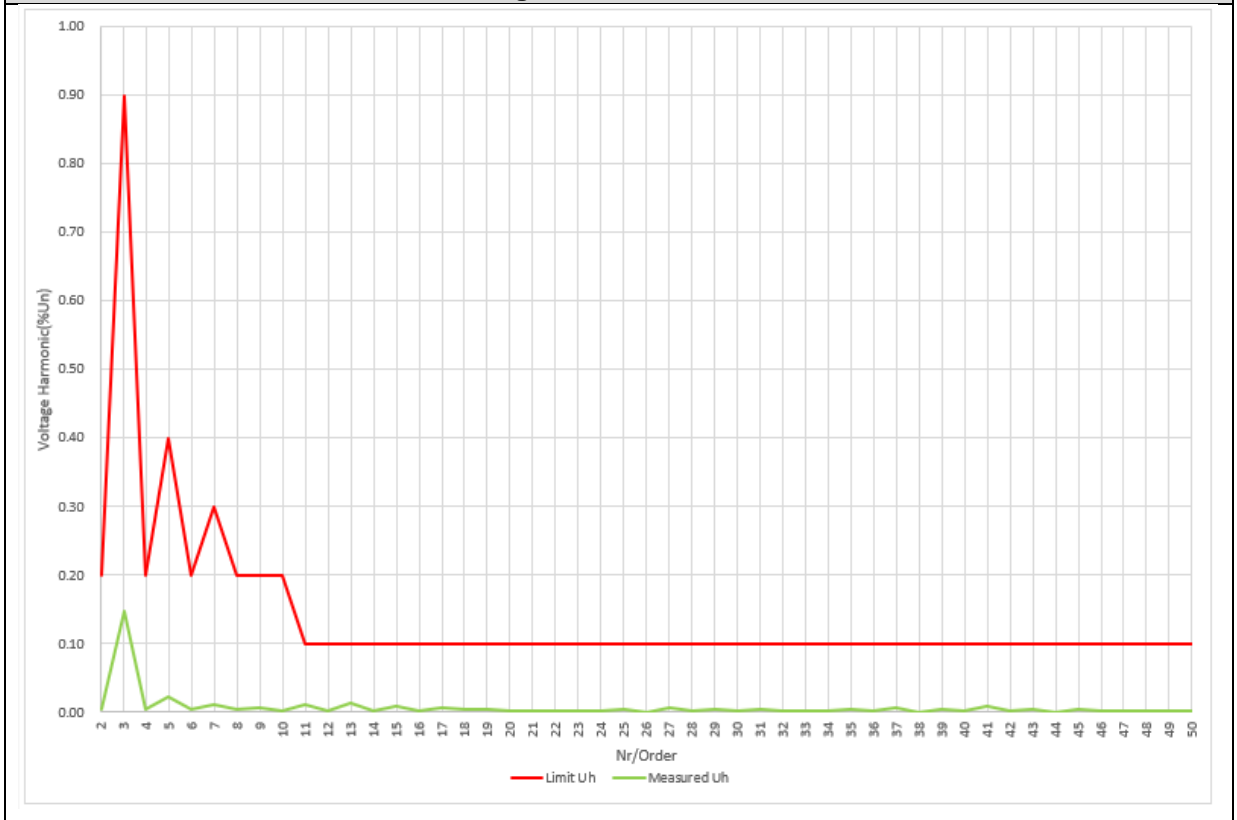

Voltage THD

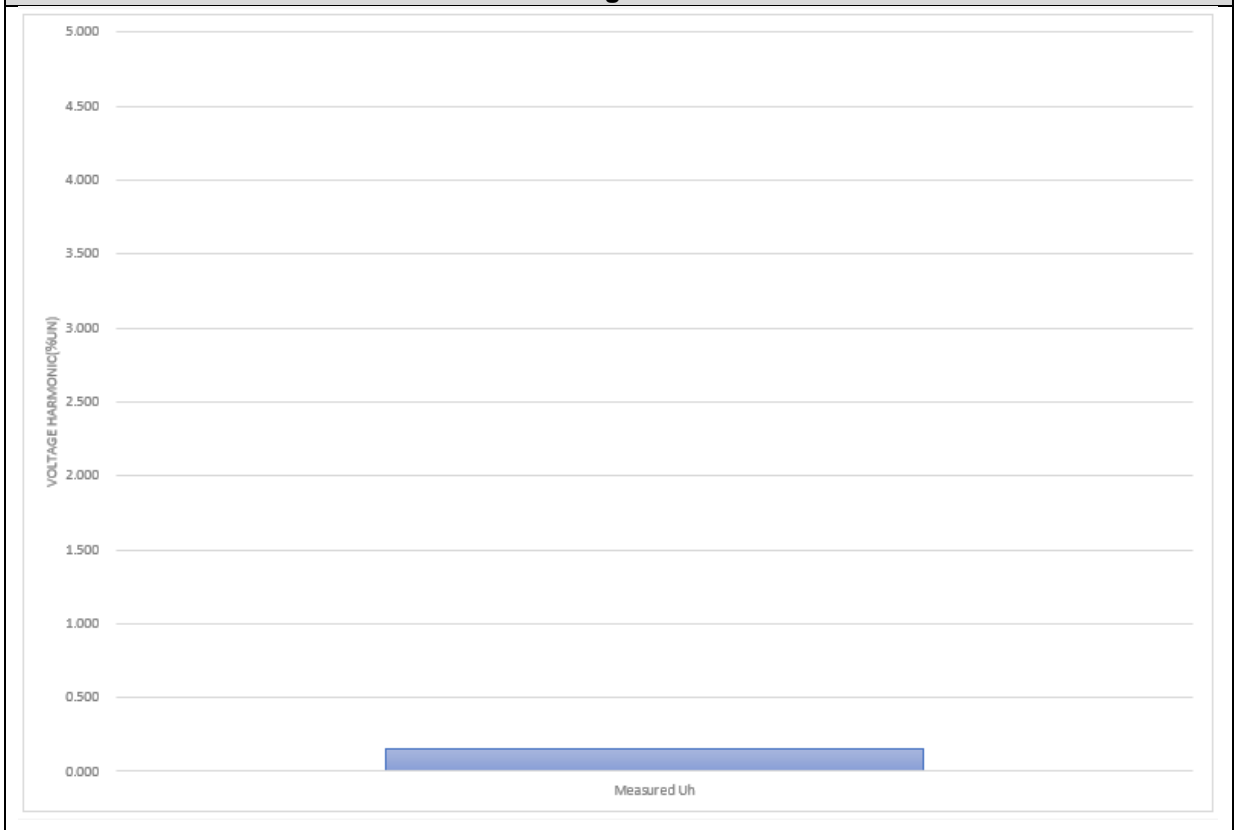

4.8 FLICKERS IN CONTINUOUS OPERATION

Measurements of voltage fluctuations in continuous operation have been measured according to the Clause 5.7 of the standard.

Limits considered are: 1.0 for Pst, 0.65 for Plt, 3.3% for dc and 4% for dmax measurements, according to the standard IEC 61000-3-11: 2017.

Test done at 100 %Pn				
Pn(%)	Limit	33 %	66 %	100 %
PST	≤ 1.0	0.07	0.07	0.07
PLT	≤ 0.65	0.07	0.07	0.07
dc [%]	≤ 3.30	0.11	0.12	0.10
dmax [%]	4	0.22	0.16	0.12

As it can be seen in the next screenshots, this test has 12 steps. The values took of Pst, Plt, dc and dmax are the most unfavorable of the 12 steps.

Running operation 33 %Pn						
Flicker Mode		Uover: ■ ■ ■ ■		YOKOGAWA ◆		
		Iover: ■ ■ ■ ■		Flicker: Complete 2:00:00		
		Count		12/12		
		Interval		10m00s/10m00s		
Element 1						
Volt Range 300V/50Hz		Element1 Judgement: Pass				
Un (U1) 229.640 V		Total Judgement: Pass				
Freq(U1) 49.999 Hz		(Element1)				
	Limit	dc[%]	dmax[%]	d(t)[ms]	Pst	Plt
		3.30	4.00	500	1.00	0.65
				3.30(%)		N: 12
No.		0.11 Pass	0.22 Pass	0 Pass	0.07 Pass	
2		0.00 Pass	0.00 Pass	0 Pass	0.07 Pass	
3		0.00 Pass	0.00 Pass	0 Pass	0.07 Pass	
4		0.10 Pass	0.14 Pass	0 Pass	0.07 Pass	
5		0.10 Pass	0.15 Pass	0 Pass	0.07 Pass	
6		0.00 Pass	0.00 Pass	0 Pass	0.07 Pass	
7		0.00 Pass	0.00 Pass	0 Pass	0.07 Pass	
8		0.00 Pass	0.00 Pass	0 Pass	0.07 Pass	
9		0.00 Pass	0.00 Pass	0 Pass	0.07 Pass	
10		0.00 Pass	0.00 Pass	0 Pass	0.07 Pass	
11		0.00 Pass	0.00 Pass	0 Pass	0.07 Pass	
12		0.00 Pass	0.00 Pass	0 Pass	0.07 Pass	
Result		Pass	Pass	Pass	Pass	0.07 Pass
Update 3600		2019/09/30 16:44:07				

Running operation 66 %Pn

Flicker Mode YOKOGAWA ◆
 Uover: ■ ■ ■ ■
 Iover: ■ ■ ■ ■ Flicker:Complete 2:00:00

Count **12/12**
 Interval **10m00s/10m00s**

Element 1
 Volt Range 300V/50Hz Element1 Judgement: Pass
 Un (U1) 230.221 V Total Judgement: Pass
 Freq(U1) 49.999 Hz (Element1)

	dc[%]	dmax[%]	d(t)[ms]	Pst	P1t
Limit	3.30	4.00	500 3.30(%)	1.00	0.65 N:12
No. 1	0.00 Pass	0.00 Pass	0 Pass	0.07 Pass	
2	0.12 Pass	0.16 Pass	0 Pass	0.07 Pass	
3	0.00 Pass	0.00 Pass	0 Pass	0.07 Pass	
4	0.00 Pass	0.00 Pass	0 Pass	0.07 Pass	
5	0.00 Pass	0.00 Pass	0 Pass	0.07 Pass	
6	0.00 Pass	0.00 Pass	0 Pass	0.07 Pass	
7	0.00 Pass	0.00 Pass	0 Pass	0.07 Pass	
8	0.00 Pass	0.00 Pass	0 Pass	0.07 Pass	
9	0.00 Pass	0.00 Pass	0 Pass	0.07 Pass	
10	0.00 Pass	0.00 Pass	0 Pass	0.07 Pass	
11	0.00 Pass	0.00 Pass	0 Pass	0.07 Pass	
12	0.00 Pass	0.00 Pass	0 Pass	0.07 Pass	
Result	Pass	Pass	Pass	Pass	0.07 Pass

Update 3600 2019/10/09 17:21:49

Running operation 100 %Pn

Flicker Mode YOKOGAWA ◆
 Uover: ■ ■ ■ ■
 Iover: ■ ■ ■ ■ Flicker:Complete 2:00:00

Count **12/12**
 Interval **10m00s/10m00s**

Element 1
 Volt Range 300V/50Hz Element1 Judgement: Pass
 Un (U1) 230.586 V Total Judgement: Pass
 Freq(U1) 50.000 Hz (Element1)

Flicker Form
Measurement

Flicker dmax

Initialize
Exec

Start

Reset

Flicker
Settings

	dc[%]	dmax[%]	d(t)[ms]	Pst	P1t
Limit	3.30	4.00	500 3.30(%)	1.00	0.65 N:12
No. 1	0.00 Pass	0.00 Pass	0 Pass	0.07 Pass	
2	0.00 Pass	0.00 Pass	0 Pass	0.07 Pass	
3	0.00 Pass	0.00 Pass	0 Pass	0.07 Pass	
4	0.00 Pass	0.00 Pass	0 Pass	0.07 Pass	
5	0.00 Pass	0.00 Pass	0 Pass	0.07 Pass	
6	0.00 Pass	0.00 Pass	0 Pass	0.07 Pass	
7	0.10 Pass	0.12 Pass	0 Pass	0.07 Pass	
8	0.00 Pass	0.00 Pass	0 Pass	0.07 Pass	
9	0.00 Pass	0.00 Pass	0 Pass	0.07 Pass	
10	0.00 Pass	0.00 Pass	0 Pass	0.07 Pass	
11	0.00 Pass	0.00 Pass	0 Pass	0.07 Pass	
12	0.00 Pass	0.00 Pass	0 Pass	0.07 Pass	
Result	Pass	Pass	Pass	Pass	0.07

Update 3600 2019/10/09 11:57:29

4.9 TRANSIENT VOLTAGE LIMITS

The purpose of this test is to verify that the inverter complies with the transient voltage limits specified below when the grid is disconnected from the inverter.

The transient voltage limits have been measured according to the Clause 5.8 of the standard and it has been used the following circuit:

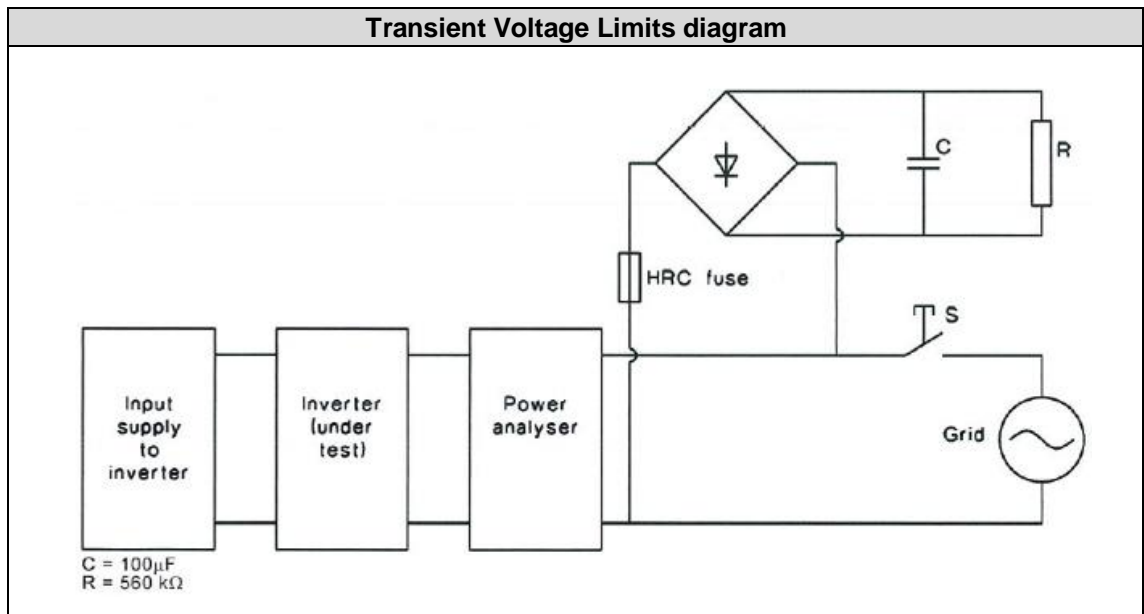

The resistor value per phase (R) has been calculated according to standard AS/NZS 4777.2:2015:

- The resistor is equivalent to 0.1% of the rated apparent power of the inverter.

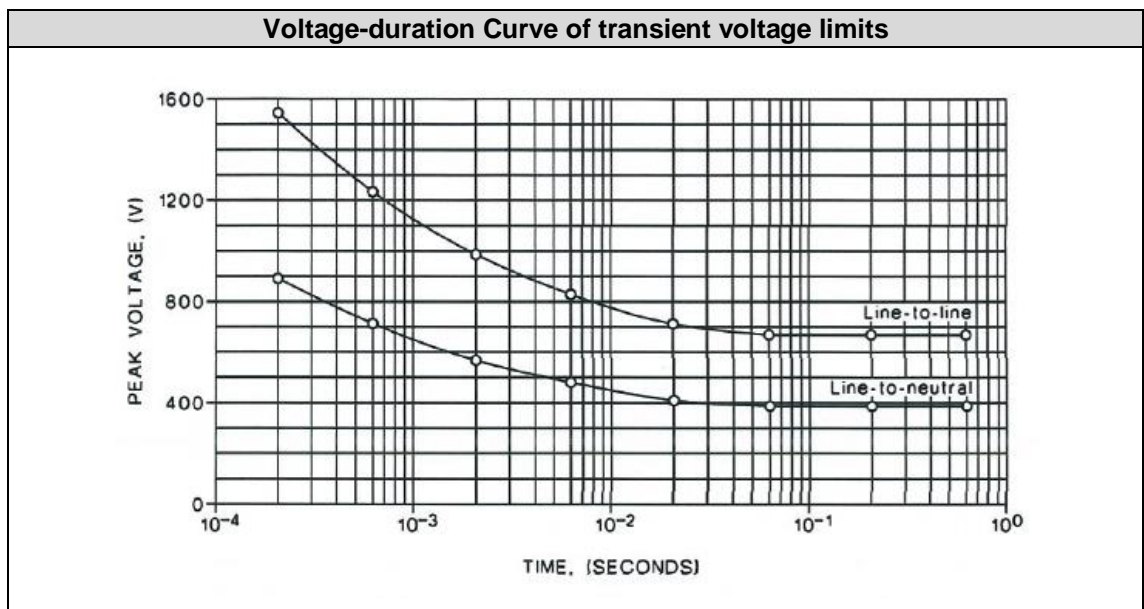

Measurements have been verified at three different active power levels, 10 %Pn, 50 %Pn and 100 %Pn. Test results are offered in following pages.

Overvoltage value measured (V)					
Duration (s)	Instantaneous Voltage				RESULT
	100 %Pn	50 %Pn	10 %Pn	Limit	
0.0002	374.1	-375.5	-445.6	±910	P
0.0006	370.0	-375.1	-449.0	±710	P
0.002	351.5	-374.0	-375.6	±580	P
0.006	337.7	-370.9	-269.5	±470	P
0.02	324.1	-360.8	-318.5	±420	P
0.06	297.5	-332.1	-292.5	±390	P
0.2	248.8	-243.8	-211.1	±390	P
0.6	143.3	-119.5	-100.0	±390	P

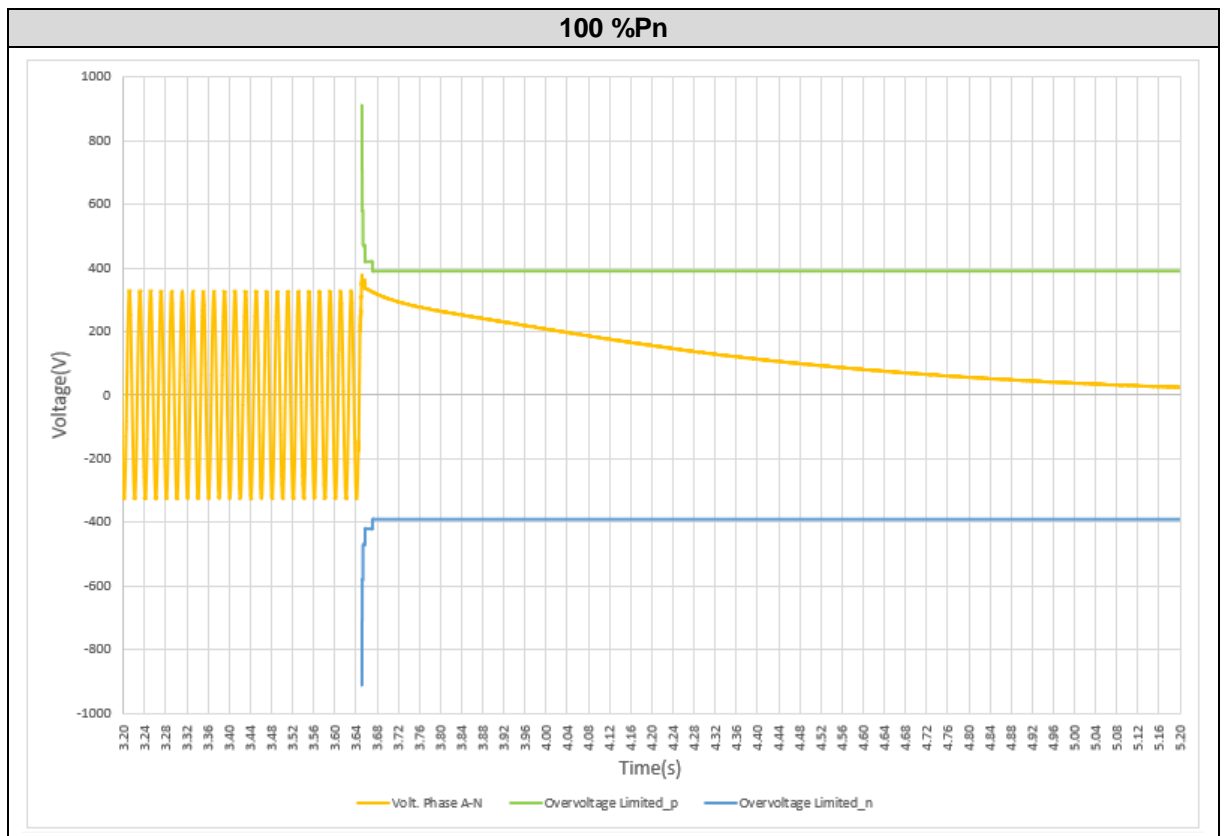

50 %Pn

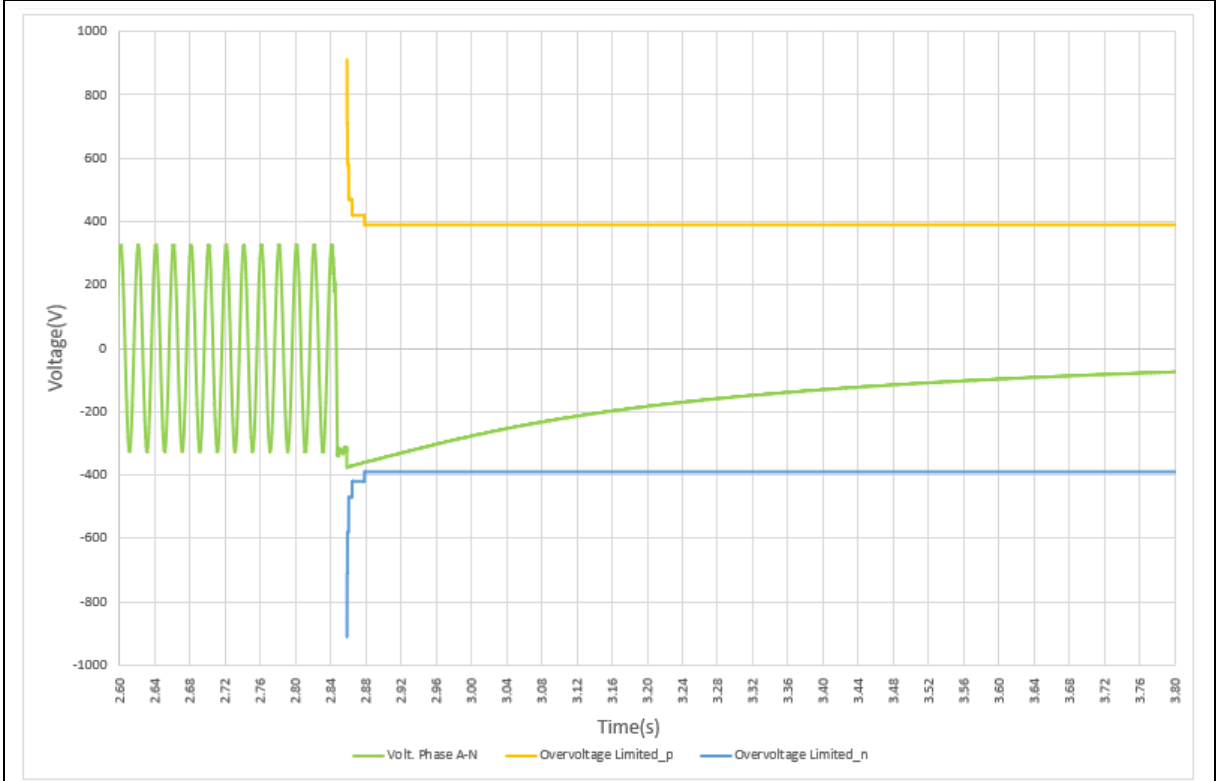

10 %Pn

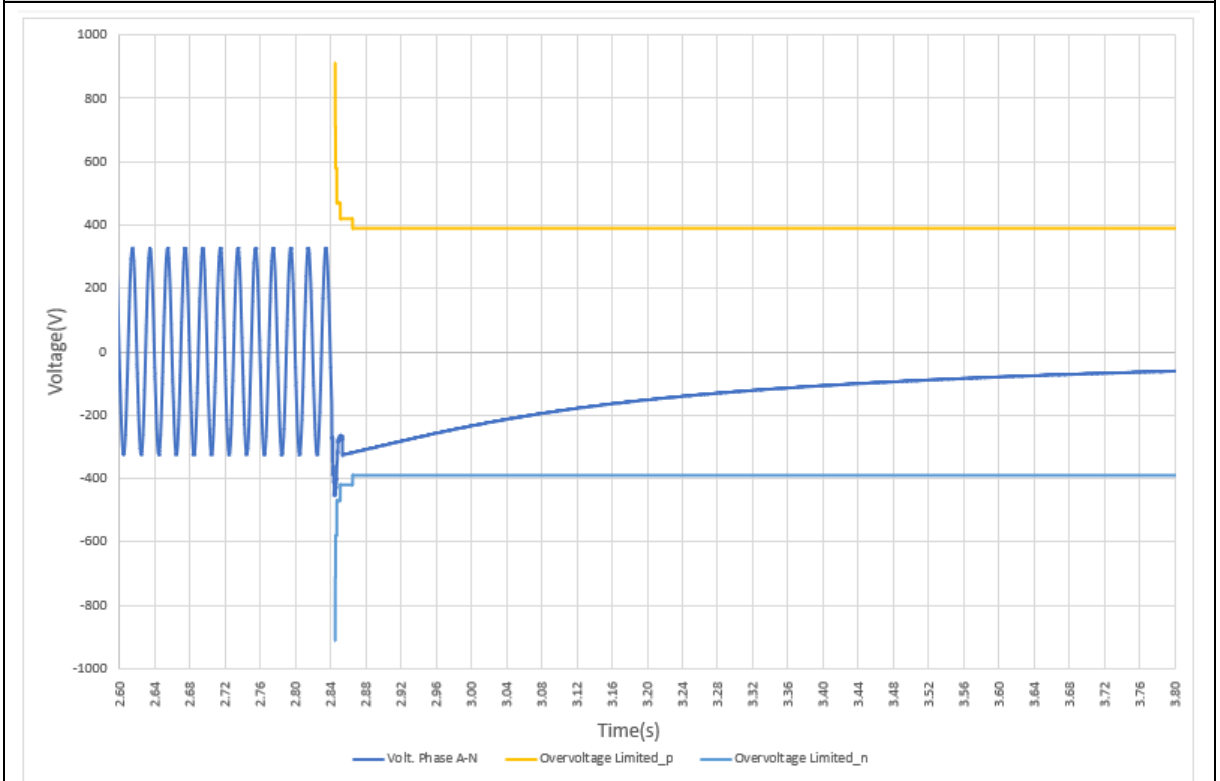

4.10 D.C. CURRENT INJECTION

The verification of DC component emission is required according to the clause 5.9 of the standard, at the specified active power levels.

	Min ~ 20 %Pn	Medium ~ 60 %Pn	Max ~ 100 %Pn
Inverter Current (A)	2.9	8.6	14.3
Max. Test value (mA)	11.5	11.9	21.0
Limited (mA)	71.5	71.5	71.5

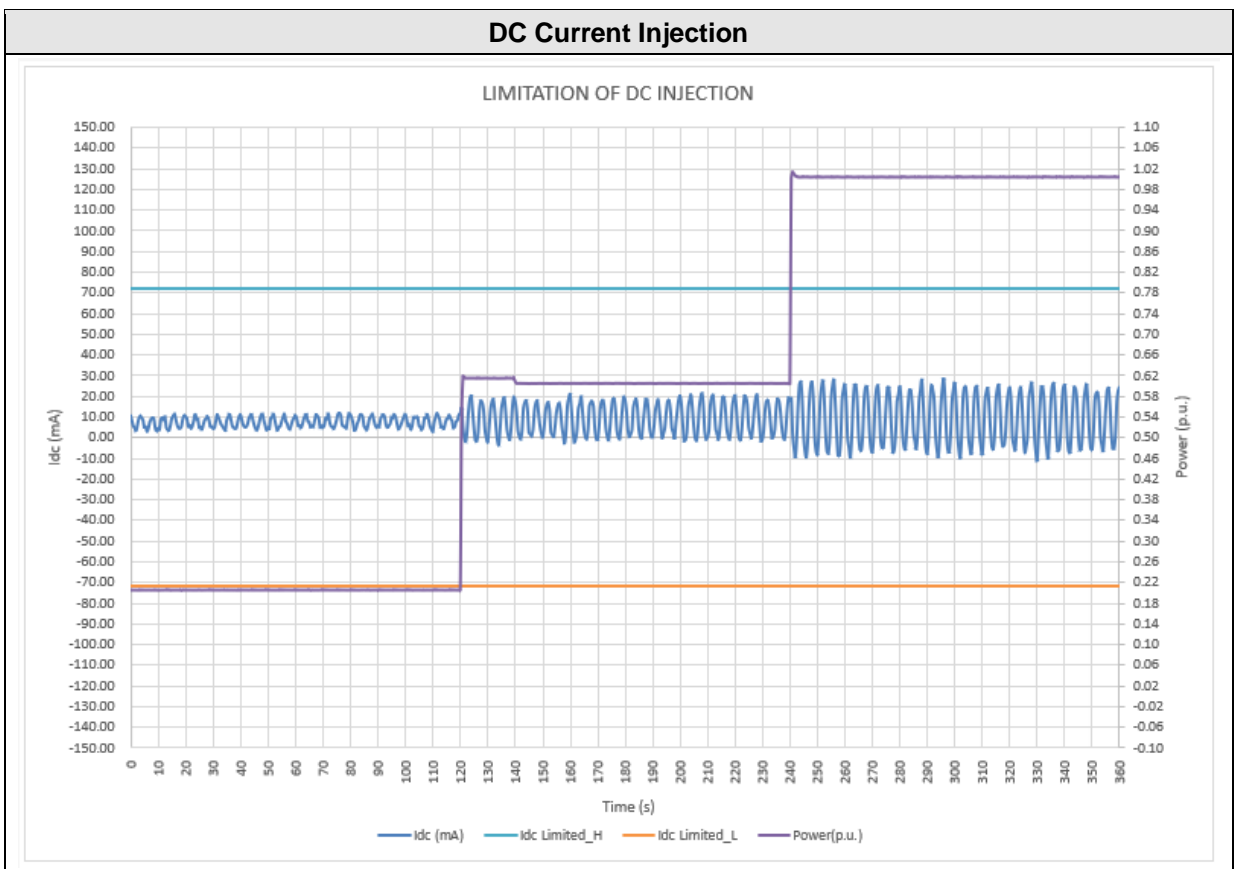

4.11 CURRENT BALANCE FOR THREE – PHASE INVERTERS

The verification of Current Balance test has been measured according to the clause 5.10 of the standard. It is not applicable due to the inverter is single phase.

4.12 OPERATIONAL MODES AND MULTIPLE MODE INVERTERS

4.12.1 Inverter Demand Response Modes (DRMs)

The inverter demand response mode DRM 0 has been tested according to Clause 6.2.1 of the standard. The inverter shall detect and initiate a response to the demand response commands within 2 s.

The DRED (Demand Response Enabling Device) connection circuit used for this test is:

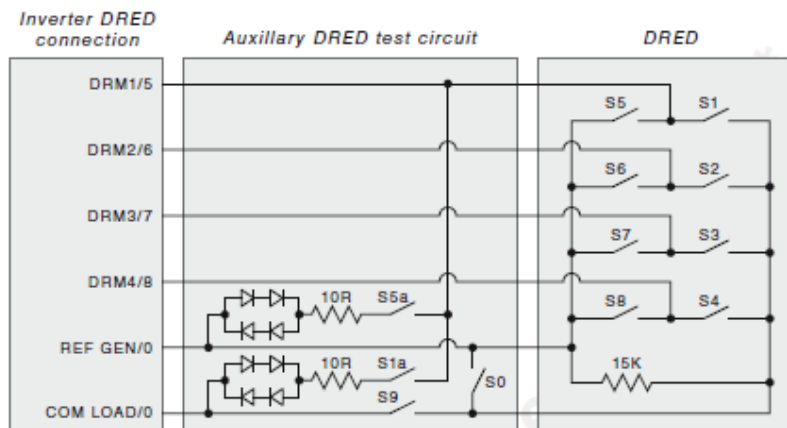

The test procedure followed has been the same as specified in the point I.2 of the standard and it is described in the following points together with test results:

- (a) With S9 switched closed and the inverter operating at 100% ± 5% of its rated current output, if the DRED switch S0 is asserted the unit shall disconnect.

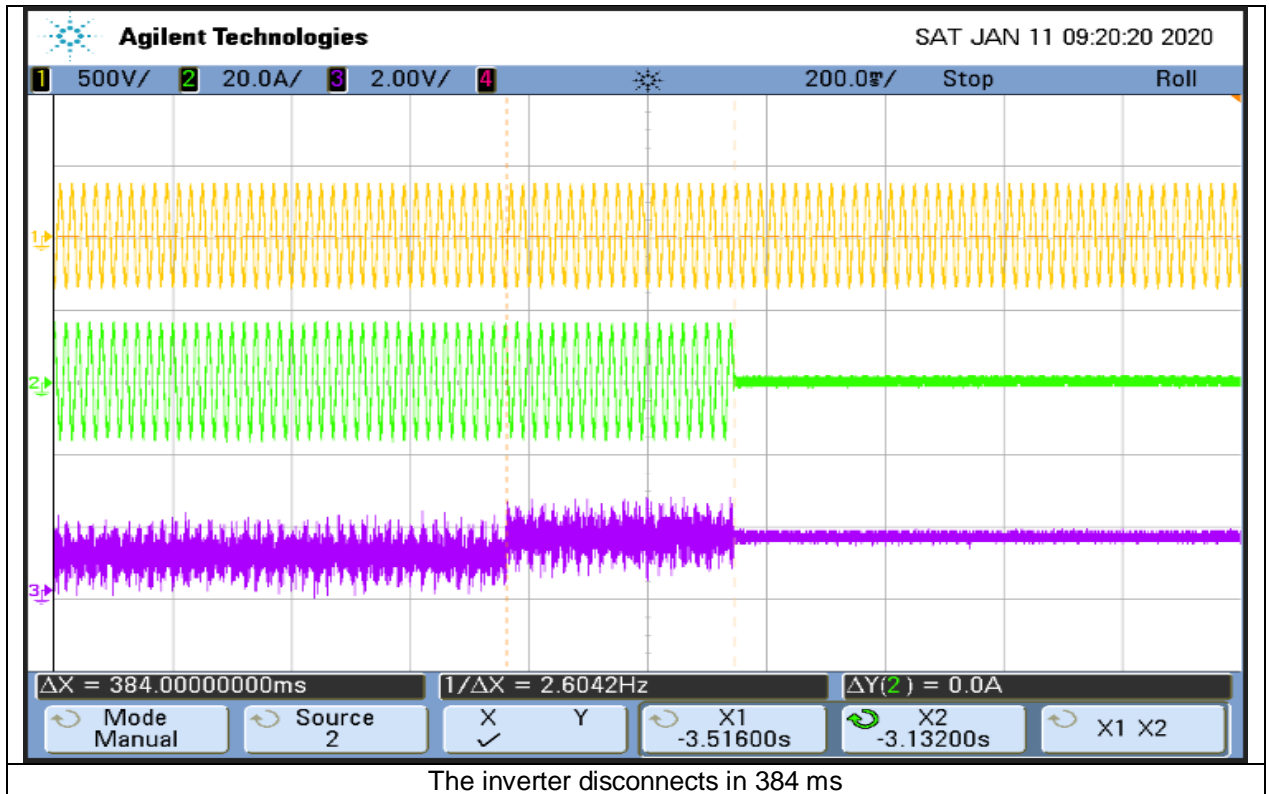

- (b) Opening S0 switched and the inverter will automatically reconnect.

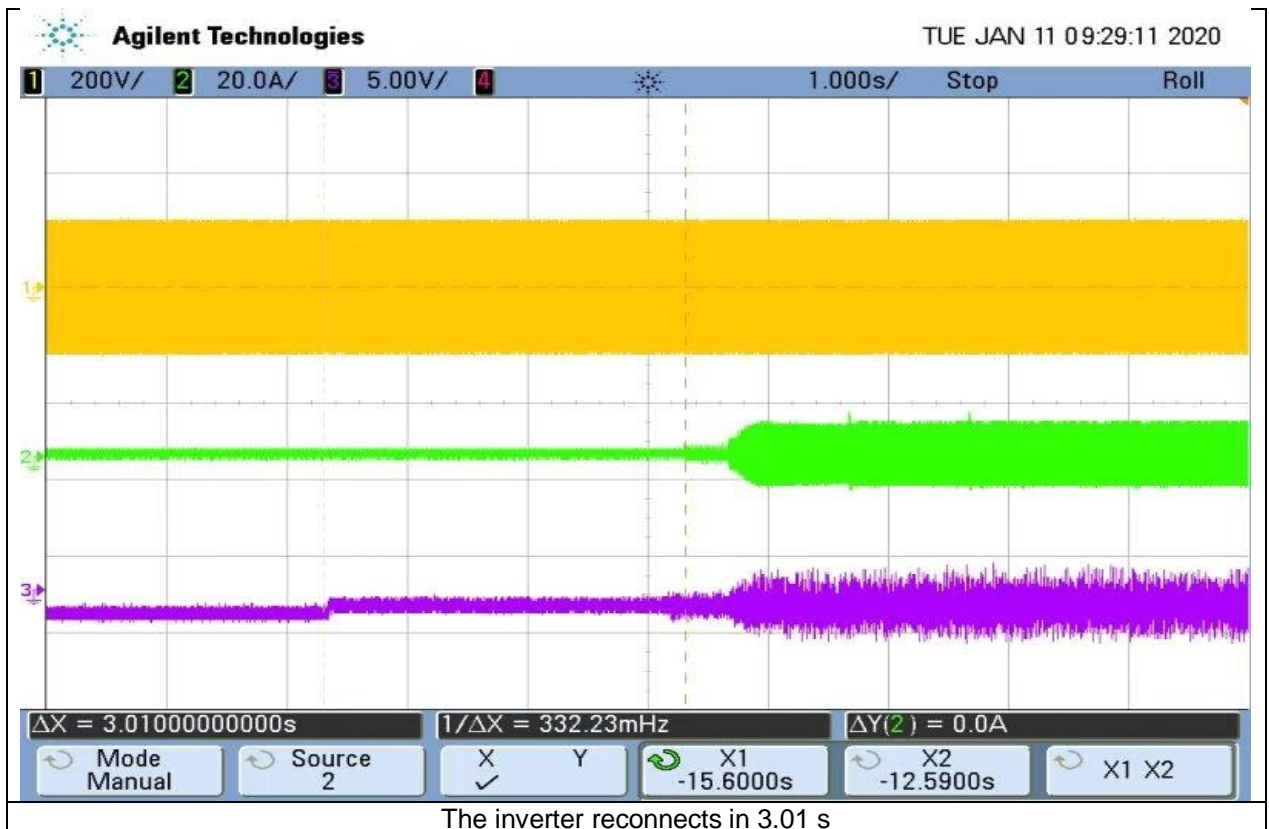

(c) Opening the switch S9 again the inverter shall disconnect.

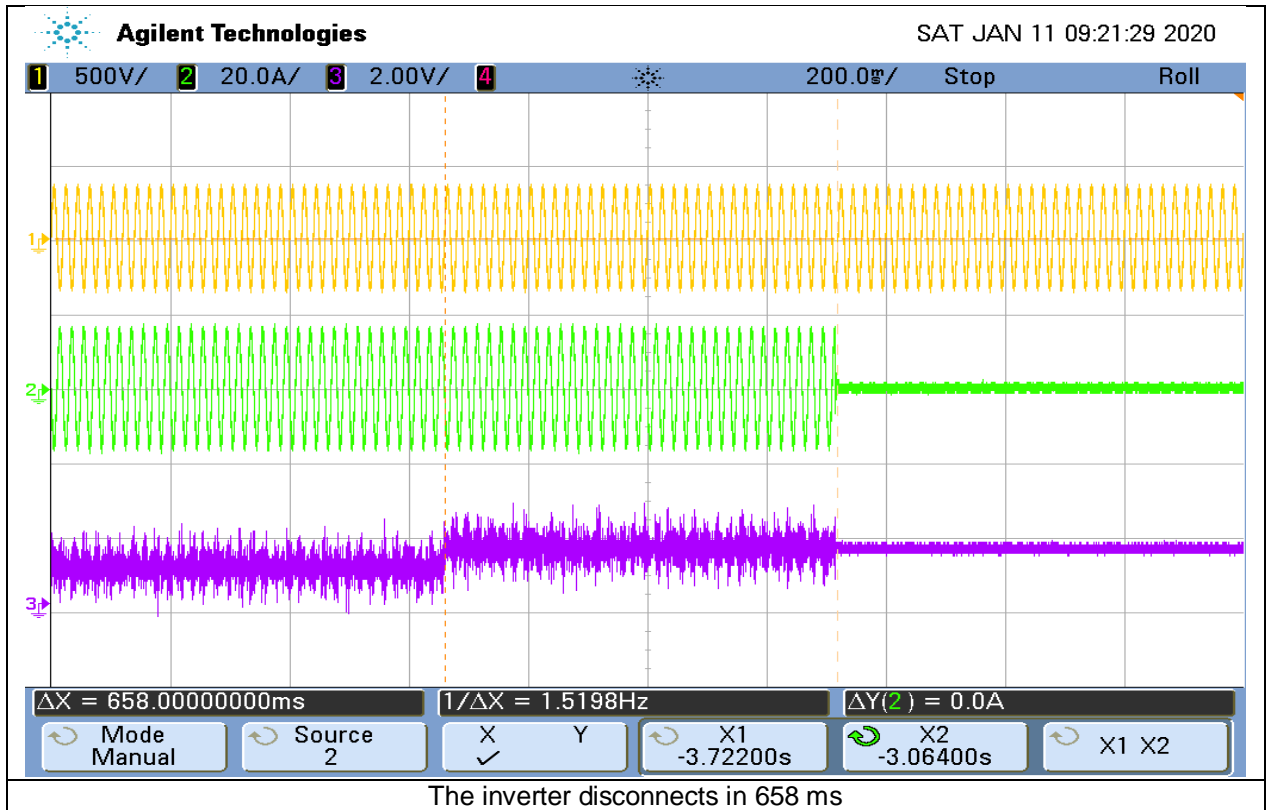

4.12.2 Test for standard operation of generator demand response modes

The procedure shall be as follows:

- (a) All DRM signals shall be removed and the input supply or inverter set-point shall be varied until the a.c. output of the inverter equals $100\% \pm 5\%$ of its rated current output. The DRM 3 and DRM 7 reactive power limits shall be set to their maximum allowed values.
- (b) DRED switch S7 shall be asserted and DRM 7 response assessed over a period of 2 s in accordance.
- (c) DRED switch S6 shall be asserted and simultaneous DRM 6 and DRM 7 response assessed over a period of 2 s in accordance.
- (d) DRED switch S7 shall be opened and DRM 6 response assessed over a period of 2 s in accordance
- (e) DRED switch S5 shall be asserted and DRM 5 response assessed in accordance.
- (f) All DRM signals shall be removed and the input supply or inverter set-point shall be varied until the a.c. output of the inverter equals $50\pm 5\%$ of the inverter's rated current output and is in a state able to respond to DRM 8.
- (g) DRED switch S8 shall be opened and DRM 6 response assessed over a period of 2 s in accordance.

The following is the test result:

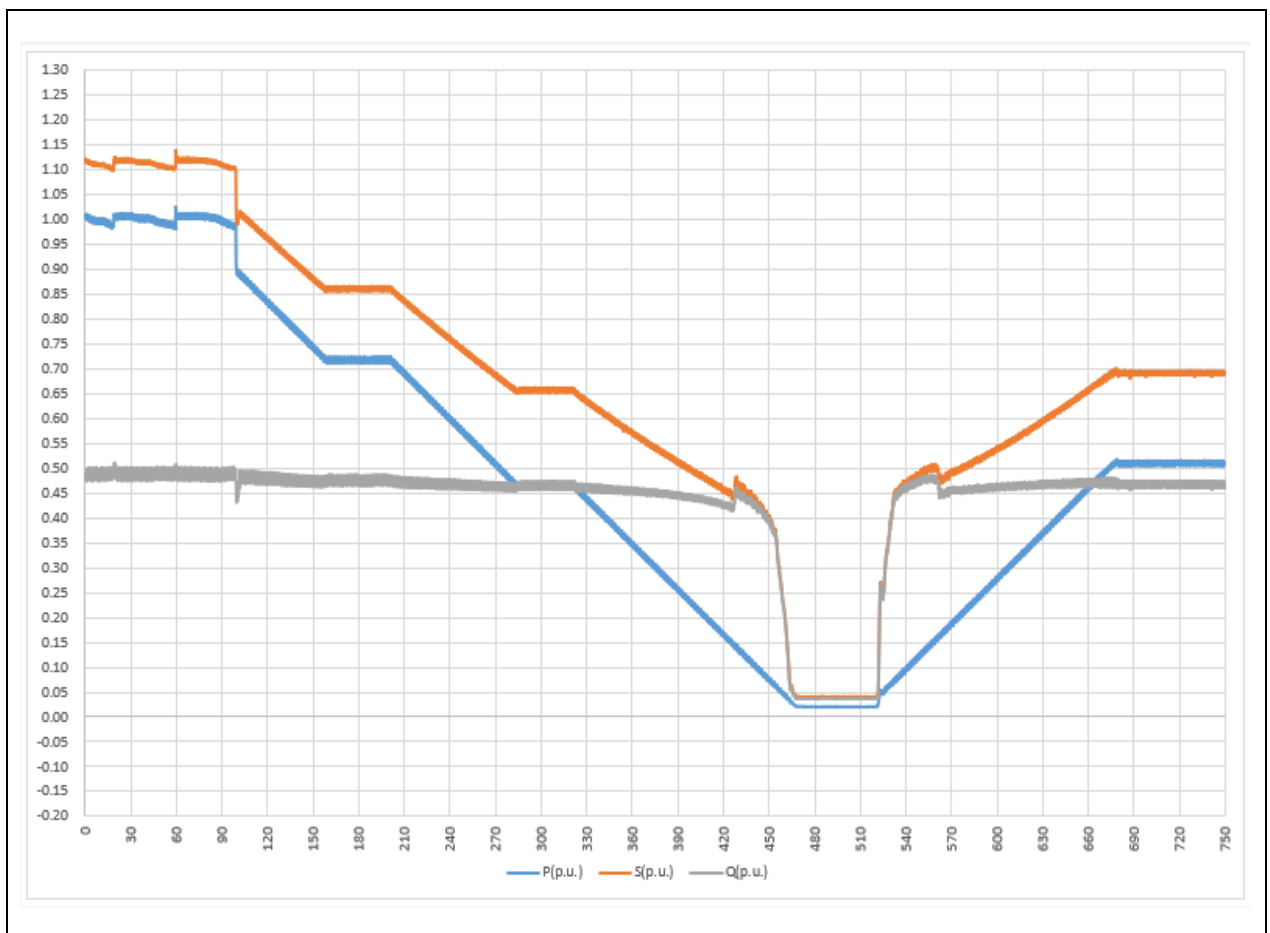

Note: Whether the slope drops or rises, the default value is 16.7%.

4.12.3 Interaction with demand response enabling device (DRED)

The inverter shall have a means of connecting to a DRED. This means of connection shall include a terminal block or RJ45 socket. The terminal block or RJ45 socket complies with the minimum electrical specifications in Table 6. The terminal block or RJ45 socket may be physically mounted in the inverter or in a separate device that remotely communicates with the inverter.

RJ45 provided. No tests needed.

4.13 Inverter Power Quality Response Modes

The inverter power quality response modes tests have been measured according to Clause 6.3 of the standard.

The different operating modes available in the inverter and evaluated are the following:

- Volt response modes.
- Fixed power factor or reactive power mode.
- Power response mode.
- Power rate limit.

4.13.1 Volt Response Modes

Volt response modes tests have been measured according to Clause 6.3.2 of the standard.

The voltage values applied for the tests of the Clauses 6.3.2.2, 6.3.2.3 and 6.3.2.4 are the following:

Reference	Australia. default value (%Un)	Range (%Un)
V1	90.0	Not applicable
V2	95.6	93.9 to 100.0
V3	108.7	102.1 to 110.9
V4	115.2	106.1 to 115.2

4.13.1.1 Volt – Watt Response Mode

Volt – Watt Response Mode has been measured according to Clauses 6.3.2.2 (PV Systems) at the required voltage and power points of operation.

The volt-watt response mode varies the output power of the inverter in response to the abnormal voltage at its terminal.

The curve required for volt-watt response mode for PV systems is defined by the picture below according to point 6.3.2.2 of the standard.

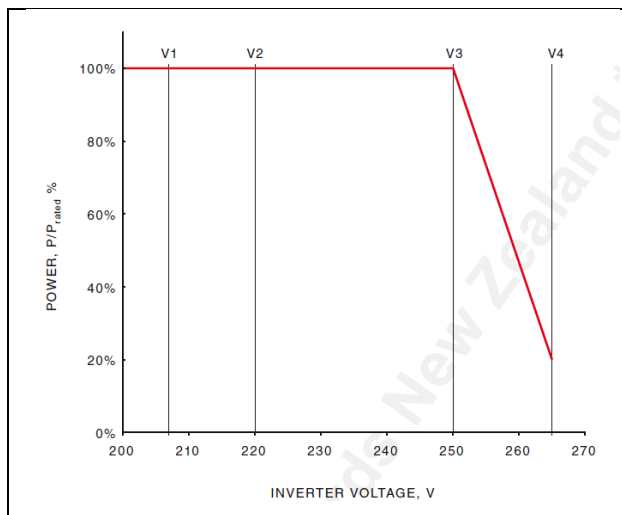

Two different tests have been performed to verify that the inverter volt-watt response is in accordance with the standard. These two curves tested prove also that volt-watt control function is configurable to different curves:

The setting values for voltage and power in the inverter have been the following:

Reference	Test 1 (for Australia setting)		Test 2 (for New Zealand setting)	
	Volt. (V)	Power (%P _n)	Volt. (V)	Power (%P _n)
V1	207	100	207	100
V2	220	100	220	100
V3	250	100	244	100
V4	265	20	255	20

4.13.1.1.1 Test 1 (for Australia setting)

Voltage desired (%Un)	Voltage Measured (%Un)	Active Power desired (%Pn)	Active Power Measured (%Pn)	Active Power Deviation (%Pn)
90.0	90.1	100.0	100.7	0.7
95.0	95.0	100.0	100.6	0.6
100.0	100.1	100.0	100.4	0.4
102.0	102.1	100.0	100.4	0.4
104.0	104.1	100.0	100.4	0.4
106.0	106.1	100.0	100.4	0.4
108.0	108.0	100.0	100.4	0.4
110.0	109.9	84.0	85.7	1.7
112.0	111.9	59.5	60.5	1.0
114.0	114.0	34.9	35.1	0.1
115.0	115.2	22.7	20.0	-2.7

Volt – Watt (Test 1)

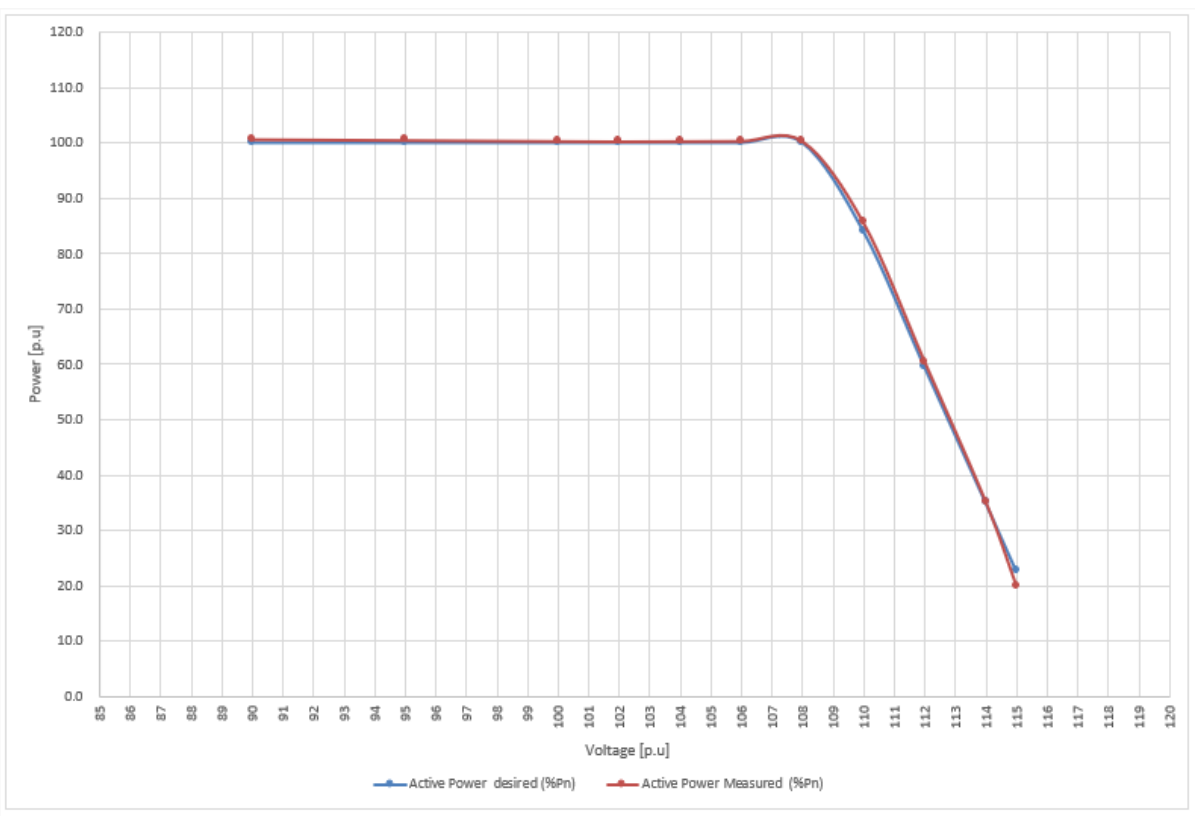
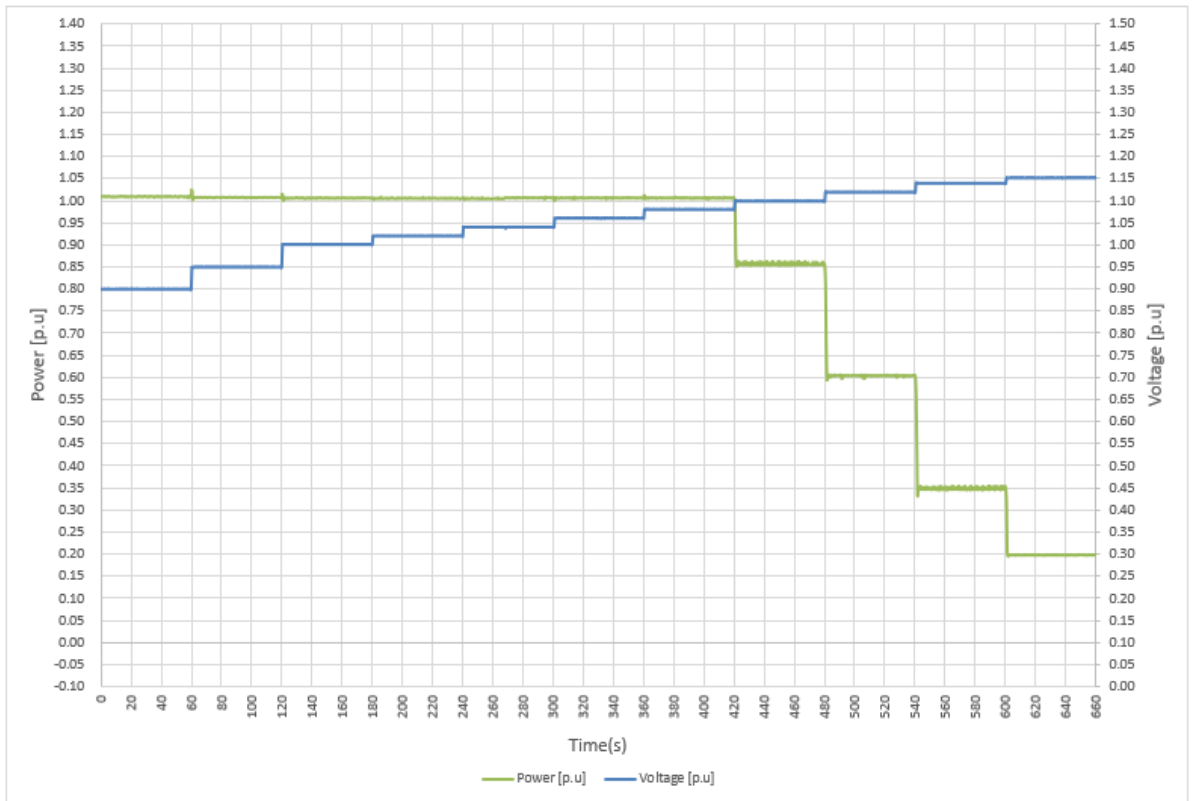

4.13.1.1.2 Test 2 (for New Zealand setting)

Voltage desired (%Un)	Voltage Measured (%Un)	Active Power desired (%Pn)	Active Power Measured (%Pn)	Active Power Deviation (%Pn)
90	90.1	100.0	100.5	0.5
96	96.0	100.0	100.6	0.6
100	100.1	100.0	100.4	0.4
104	104.0	100.0	100.3	0.3
106	106.1	100.0	100.3	0.3
108	108.0	68.0	68.9	0.9
109	109.0	51.3	51.1	-0.2
110	110.1	34.5	33.2	-1.3

Volt – Watt (Test 2)

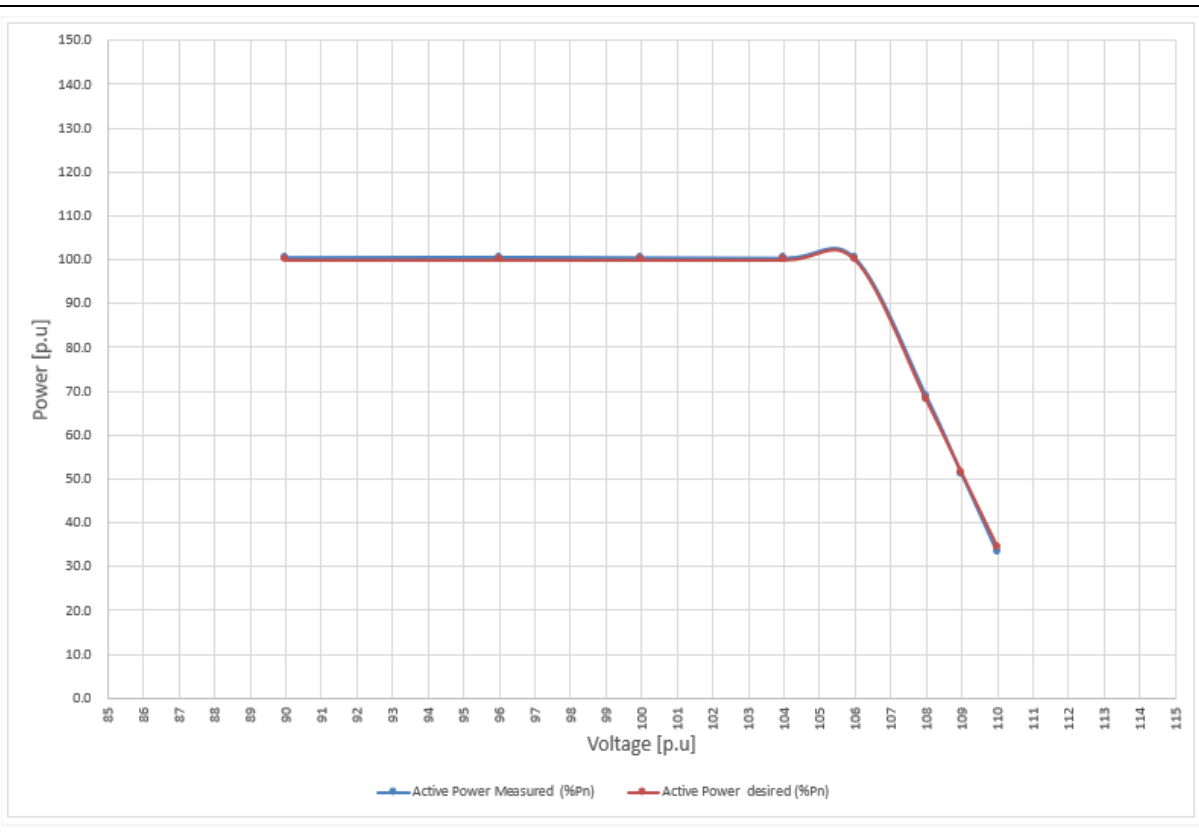
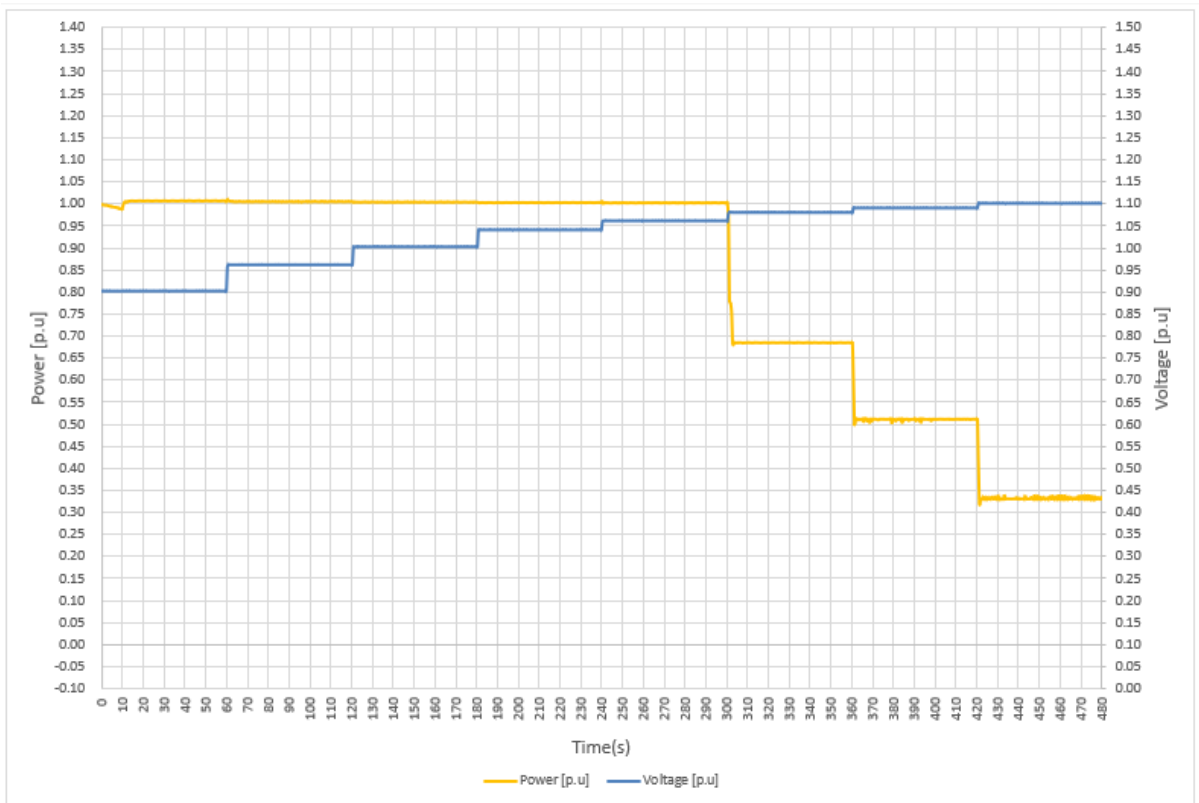

4.13.1.2 Volt –Var Response Mode

Volt – Var Response Mode has been measured according to Clause 6.3.2.3 of the standard, at the required voltage and VAr points of operation.

The default VAr level (30% lagging/leading) for Australia setting has been tested as following:

Q = 30 %Sn				
Voltage Desired (%Un)	Voltage Measured (%Un)	Reactive Power desired (%Sn)	Reactive Power Measured (%Sn)	Reactive Power Deviation (%Sn)
85	85.0	30.0	33.4	3.4
90	89.9	30.0	33.7	3.7
92	91.9	19.4	19.8	0.4
95	95.0	3.5	3.5	0.0
100	100.2	0.0	4.2	4.2
102	102.1	0.0	4.5	4.5
104	104.0	0.0	3.5	3.5
108	108.1	0.0	0.9	0.9
110	110.0	-6.0	-7.1	-1.1
112	112.2	-15.2	-16.1	-0.9
115	115.4	-29.0	-27.5	1.5

Volt - Var 30 %Sn (Test 1)

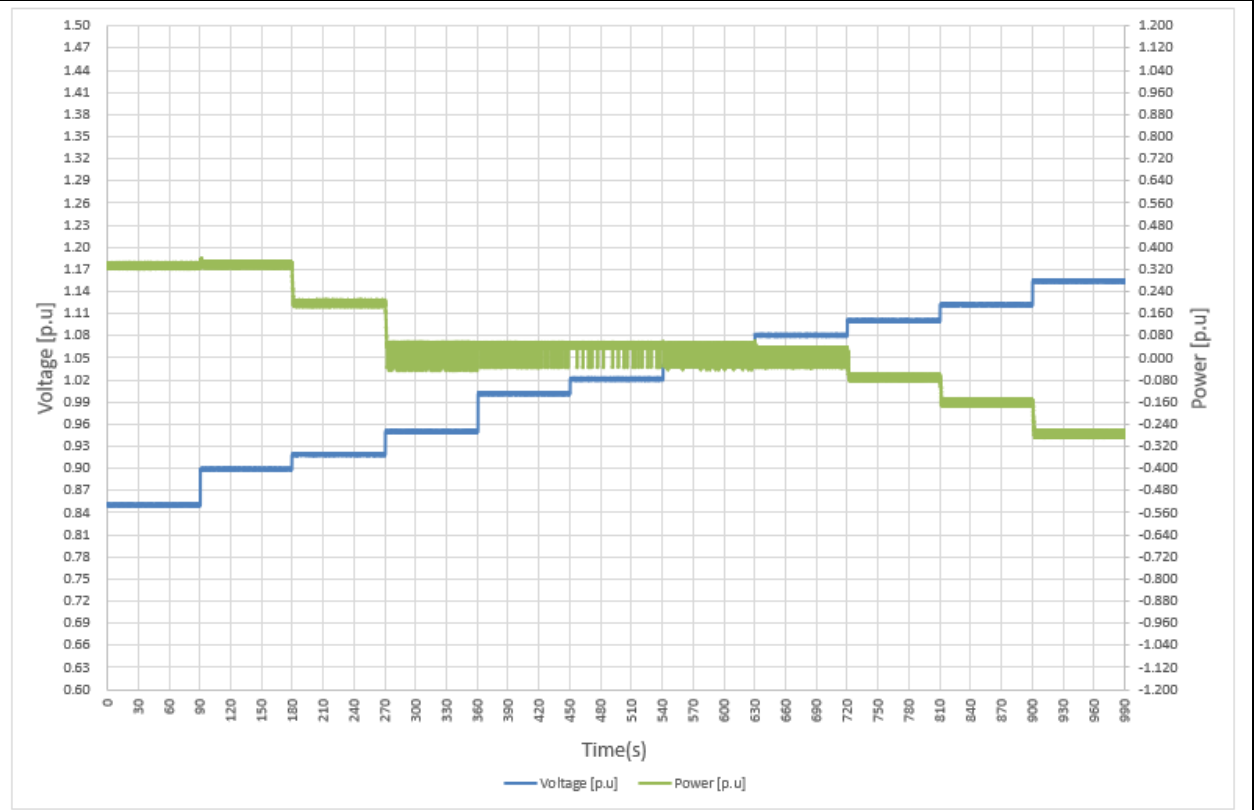

4.13.1.3 Voltage Balance Modes

The requirement of Voltage Balance Modes test has to be verified according to the clause 6.3.2.4 of the standard.

It is not applicable due to the inverter is single phase.

4.13.2 Fixed Power Factor Mode and Reactive Power Mode

The verification of reactive power supply capability test has been measured according to the clause 6.3.3 of the standard.

Three different tests have been done:

- Test 1: Rectangular Curve Q fixed ($Q=\pm 30\% S_n$)
- Test 2: Triangular Curve PF fixed ($PF=\pm 0.8$)
- Test 3: Semicircular Curve S fixed ($S=100\% S_n$)

4.13.2.1 Test 1: Rectangular Curve (Q =±30 %Sn)

This test verifies the capability of the inverter to provide a fixed value of reactive power. In addition, it is verified the Q control mode.

Allowed tolerance to be considered is 5 %Sn when possible.

The following table shows the test results:

Rectangular Curve (Q=30.0 %Sn / Inductive)					
P Desired (%Sn)	P measured (%Sn)	Q desired (%Sn)	Q measured (%Sn)	Q Deviation (%Sn)	Power Factor (cos φ)
5	4.7	30.0	24.2	-5.8	0.190
15	15.3	30.0	30.9	0.9	0.447
25	25.9	30.0	31.8	1.8	0.632
35	36.6	30.0	31.5	1.5	0.758
45	46.9	30.0	31.8	1.8	0.828
55	57.1	30.0	32.1	2.1	0.872
65	67.3	30.0	32.3	2.3	0.901
75	77.4	30.0	31.9	1.9	0.924
85	87.4	30.0	31.5	1.5	0.941
95	97.4	30.0	31.9	1.9	0.950
100	100.4	30.0	32.0	2.0	0.953

Rectangular Curve (Q=30.0 %Sn / Capacitive)					
P Desired (%Sn)	P measured (%Sn)	Q desired (%Sn)	Q measured (%Sn)	Q Deviation (%Sn)	Power Factor (cos φ)
5	4.5	-30.0	-28.5	1.5	0.155
15	15.1	-30.0	-32.3	-2.3	0.426
25	25.8	-30.0	-30.5	-0.5	0.647
35	36.5	-30.0	-30.2	-0.2	0.771
45	46.8	-30.0	-30.3	-0.3	0.840
55	57.1	-30.0	-29.9	0.1	0.886
65	67.2	-30.0	-29.8	0.2	0.914
75	77.3	-30.0	-29.9	0.1	0.933
85	87.4	-30.0	-29.5	0.5	0.948
95	97.4	-30.0	-29.4	0.6	0.957
100	100.5	-30.0	-29.5	0.5	0.960

Note: When operating in this mode for all inverter current outputs below 25% of rated current, it is acceptable for the displacement power factor to be controlled such that the vars supplied or drawn are limited.

Test results are represented at diagrams below.

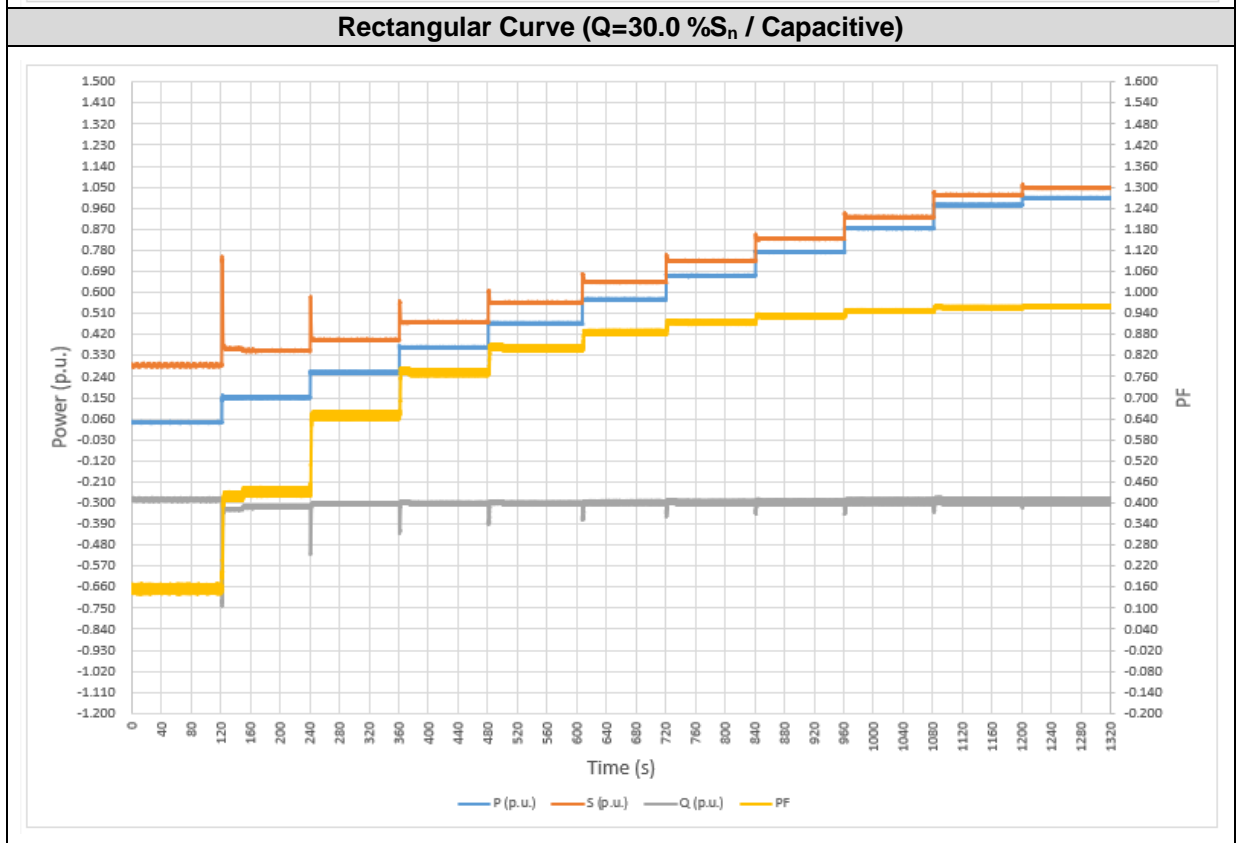
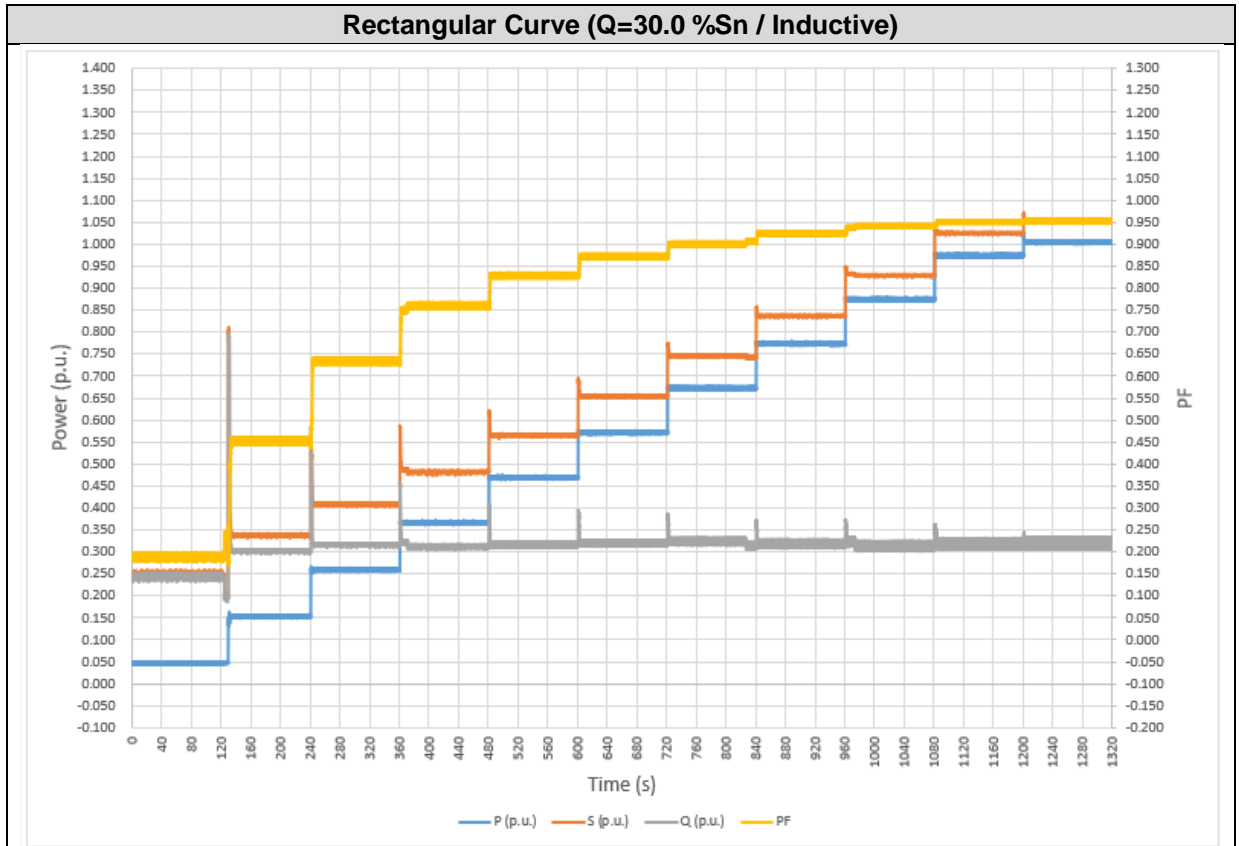

Rectangular Curve (Capacitive vs Inductive)

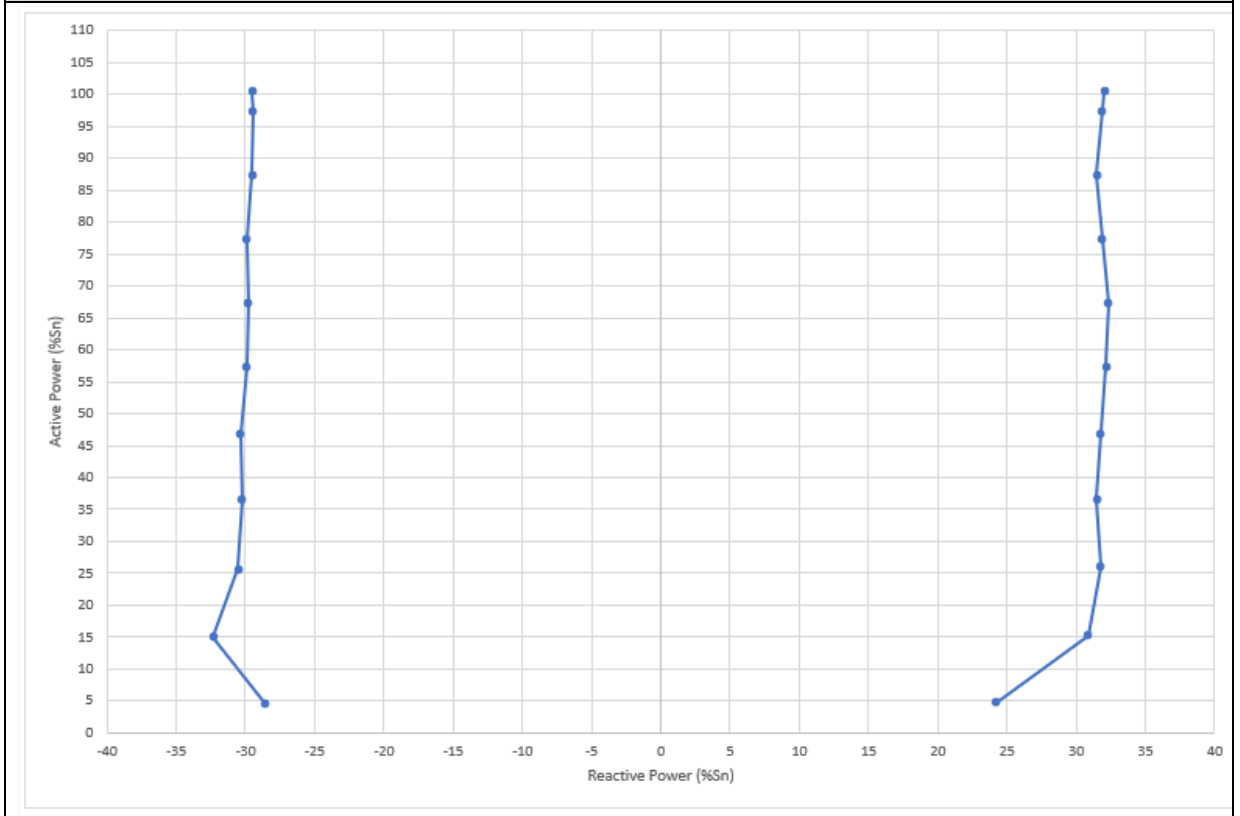

4.13.2.2 Test 2: Triangular Curve (PF=±0.8)

This test verifies the capability of the inverter to provide a fixed value of power factor. In addition, it is verified the PF control mode.

At high active power levels, the reactive power provided by the inverter is automatically limited by the inverter in order to protect against over current.

The maximum tolerance allowed for the measured Power Factor is ± 0.01 , for measurements from 25 %Sn.

The following table shows the test results:

Fixed Power Factor (PF=0.80 / Inductive)					
P Desired (%Sn)	P measured (%Sn)	Q measured (%Sn)	Power Factor desired (cos ϕ)	Power Factor measured (cos ϕ)	Power Factor Deviation (cos ϕ)
5	5.0	4.9	0.800	0.708	-0.092
15	15.5	11.8	0.800	0.795	-0.005
25	26.1	19.7	0.800	0.797	-0.003
35	36.7	27.8	0.800	0.797	-0.003
45	46.8	35.5	0.800	0.797	-0.003
55	57.0	43.1	0.800	0.797	-0.003
65	67.0	50.7	0.800	0.797	-0.003
75	76.9	58.3	0.800	0.797	-0.003
85	85.7	64.9	0.800	0.797	-0.003
95	85.7 (*)	64.9	0.800	0.797	-0.003
100	85.8 (*)	64.9	0.800	0.797	-0.003

(*) The inverter can't reach the desired active power above 85 %Pn due to it is reactive power priority in this mode.

The following table and graphs show test results for measurements of power factor set to 0.80 capacitive:

Fixed Power Factor (PF=0.80 / Capacitive)					
P Desired (%Sn)	P measured (%Sn)	Q measured (%Sn)	Power Factor desired (cos ϕ)	Power Factor measured (cos ϕ)	Power Factor Deviation (cos ϕ)
5	4.9	3.8	0.800	0.792	-0.008
15	15.5	-11.5	0.800	0.802	0.002
25	26.0	-19.5	0.800	0.800	0.000
35	36.6	-27.0	0.800	0.805	0.005
45	46.8	-35.0	0.800	0.801	0.001
55	56.8	-42.0	0.800	0.804	0.004
65	66.8	-50.8	0.800	0.796	-0.004
75	76.8	-57.9	0.800	0.798	-0.002
85	82.5	-62.2	0.800	0.798	-0.002
95	82.5 (*)	-62.3	0.800	0.798	-0.002
100	82.6 (*)	-62.2	0.800	0.799	-0.001

(*) The inverter can't reach the desired active power above 85%Pn due to it is reactive power priority in this mode.

Triangular Curve (PF=0.80 / Inductive)

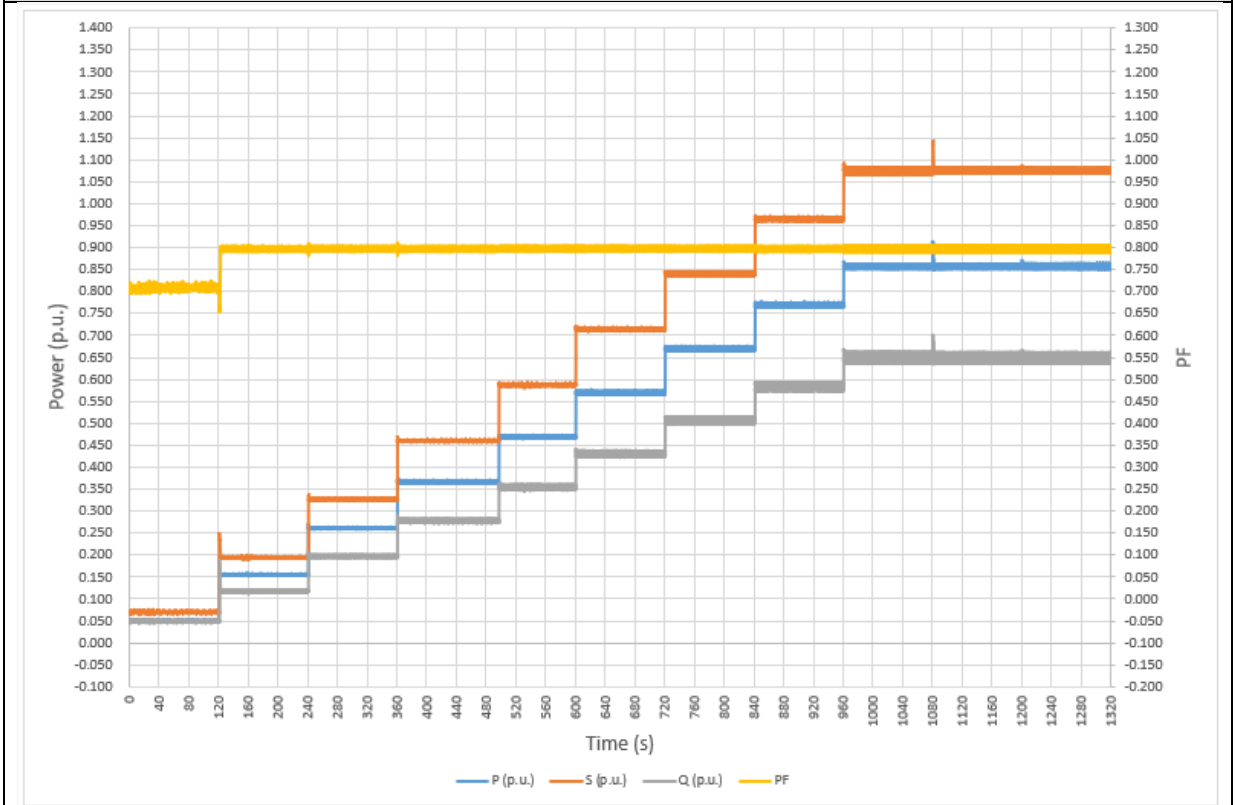

Triangular Curve (PF=0.8 / Capacitive)

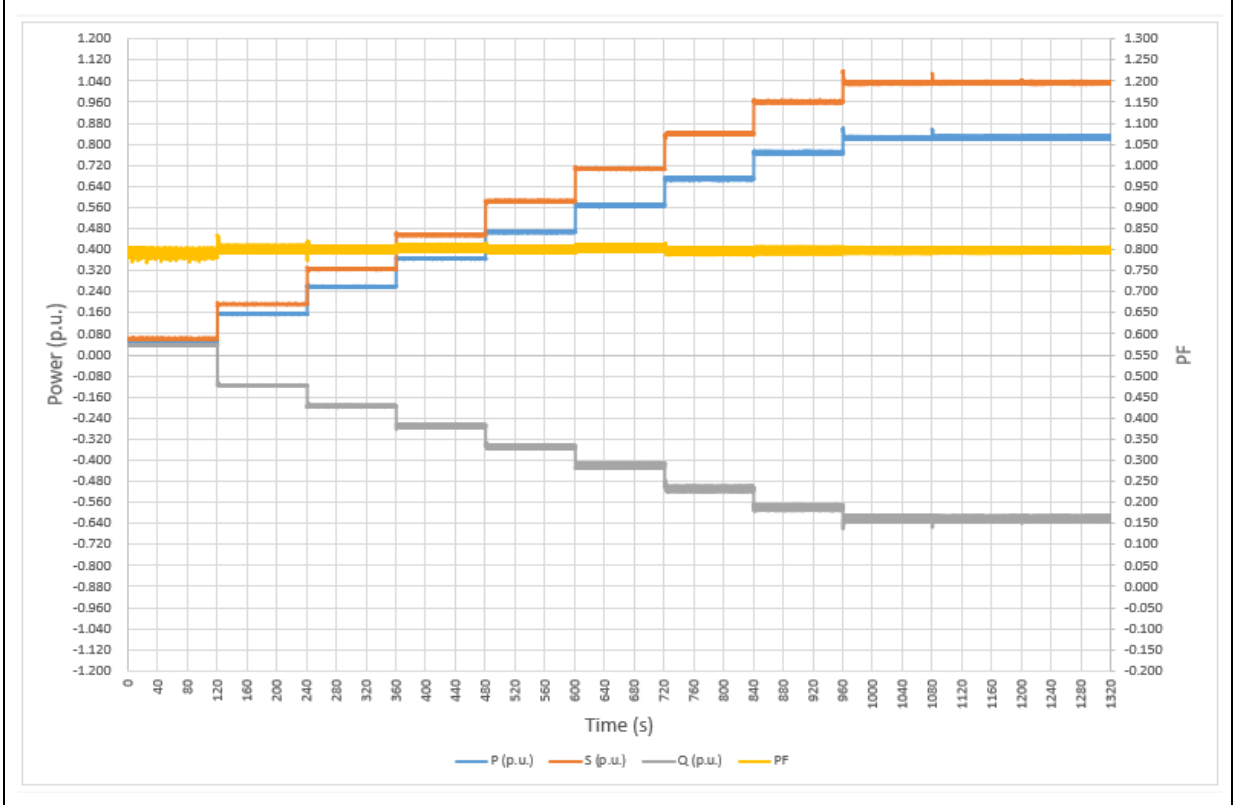

Triangular Curve (Inductive vs Capacitive)

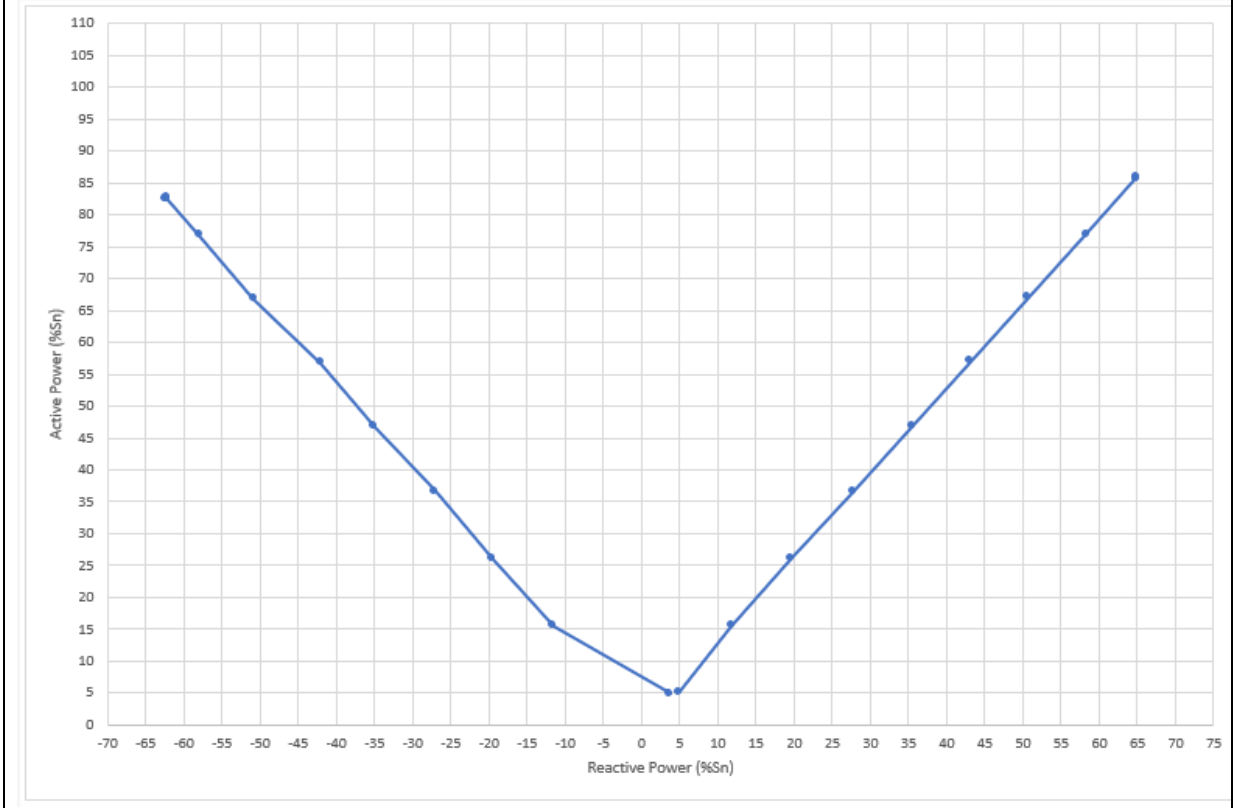

4.13.2.3 Test 3: Semicircular Curve (S=100 %Sn)

This test verifies the capability of the inverter to provide a fixed value of apparent power.

Allowed tolerance for reactive power measurements is to be considered inside $\pm 5\%$ Sn when active power more than 25%.

The test is waived due to the manufacturer doesn't provide this operation mode.

4.13.3 Characteristics Power Factor Curve for Cos ϕ (Power Response)

The Characteristic Power Factor Curve for $\cos \phi$ (Power response) has been measured according to the Clause 6.3.4 of the standard. Three tests have been done to verify an adjustable curve from PF inductive to PF capacitive.

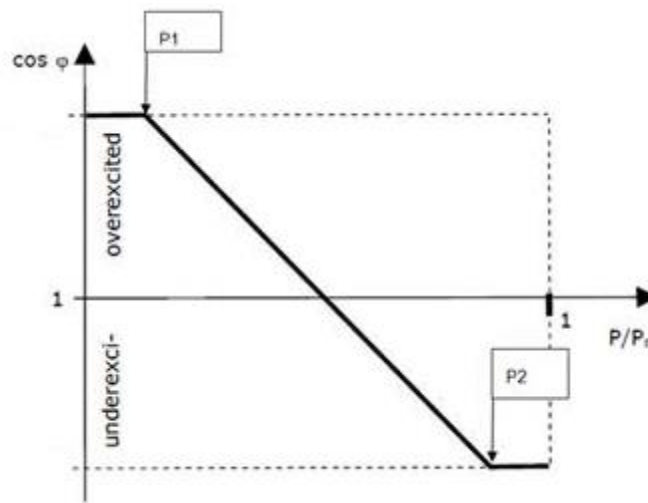

These tests have been performed as detailed in following table:

Test N°	Point P1		Point P2	
	Active Power (%Sn)	Power Factor	Active Power (%Sn)	Power Factor
1	20%	0.95	90%	-0.95
2	20%	0.90	90%	-0.90
3	20%	0.95	80%	-0.95

For all tests above detailed, the unity power factor 1.0 is reached at 50 %Pn.

There is allowed a maximum tolerance for power factor measurement inside ± 0.01 .

4.13.3.1 Test 1

In this test it is verified that the power factor varies linearly from PF = 0.95 (inductive) at 20 %Pn, PF = 1 at 50 %Pn, PF = 0.95 (capacitive) at 90 %Pn. The following table shows the obtained test results:

P Desired (%Sn)	P measured (%Sn)	Q measured (%Sn)	Power Factor desired (cos φ)	Power Factor measured (cos φ)	Power Factor Deviation (cos φ)
20	20.6	7.0	0.950	0.947	-0.003
30	30.9	7.5	0.967	0.972	0.005
40	41.4	7.4	0.983	0.984	0.001
50	51.5	2.2	1.000	0.999	-0.001
60	61.5	-11.1	0.988	0.984	-0.004
70	71.4	-16.4	0.975	0.974	-0.001
80	81.3	-21.6	0.963	0.966	0.003
90	91.1	-4.5	0.950	0.950	0.000

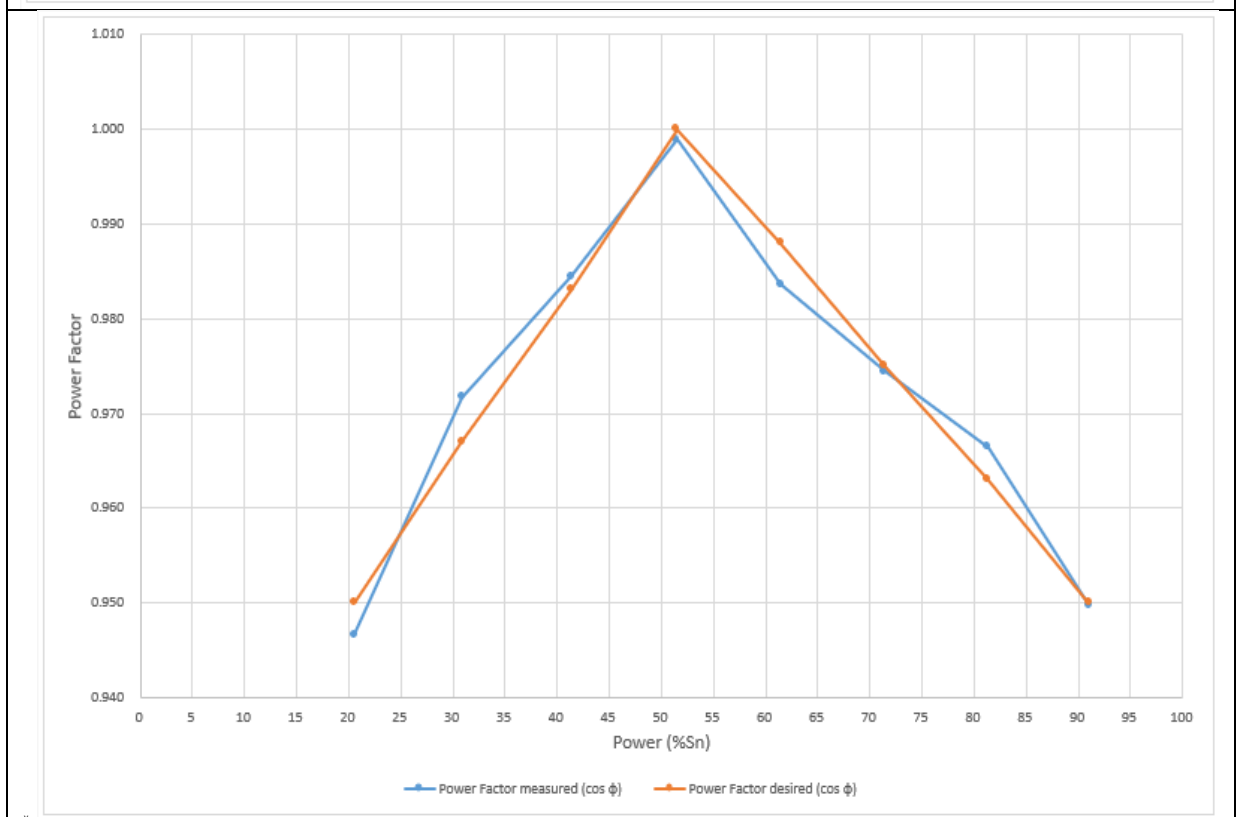
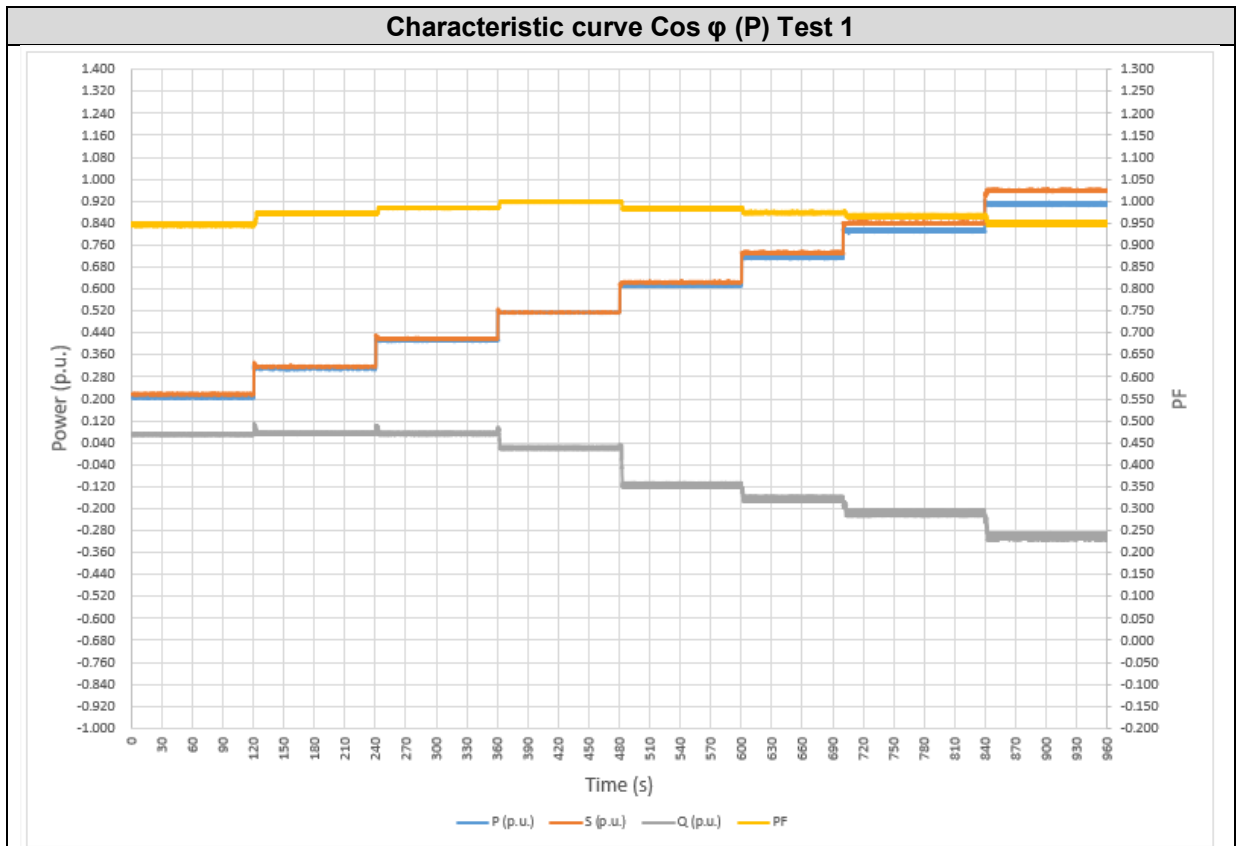

4.13.3.2 Test 2

In this test it is verified that the power factor varies linearly from PF = 0.90 (inductive) at 20 %Pn, PF = 1 at 50 %Pn, PF = 0.90 (capacitive) at 90 %Pn. The following table shows the obtained test results:

P Desired (%Sn)	P measured (%Sn)	Q measured (%Sn)	Power Factor desired (cos φ)	Power Factor measured (cos φ)	Power Factor Deviation (cos φ)
20	20.9	10.3	0.900	0.897	-0.003
30	31.5	12.6	0.933	0.928	-0.005
40	42.0	12.1	0.967	0.961	-0.006
50	52.3	2.4	1.000	0.999	-0.001
60	62.4	-14.2	0.975	0.975	0.000
70	72.4	-21.4	0.950	0.959	0.009
80	82.3	-34.1	0.925	0.924	-0.001
90	92.1	-43.4	0.900	0.904	0.004

Characteristic curve Cos ϕ (P) Test 2

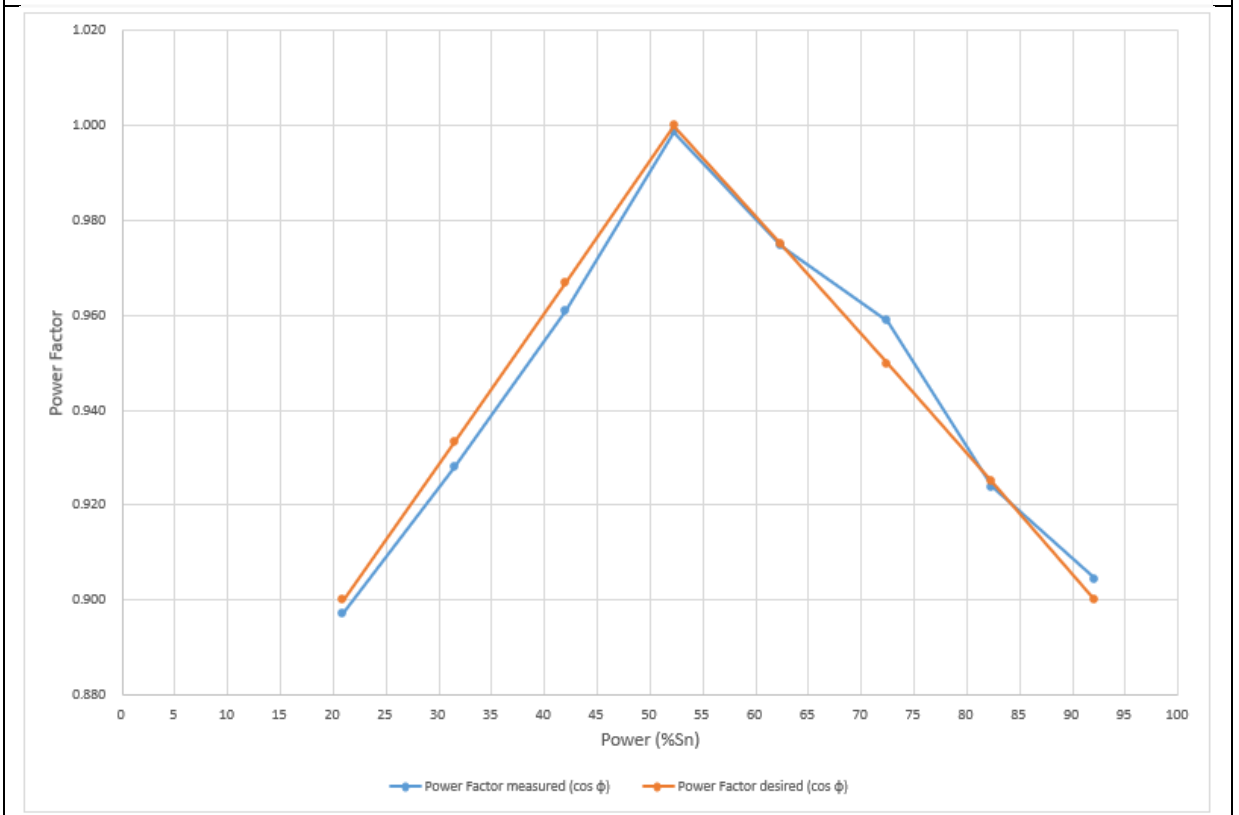
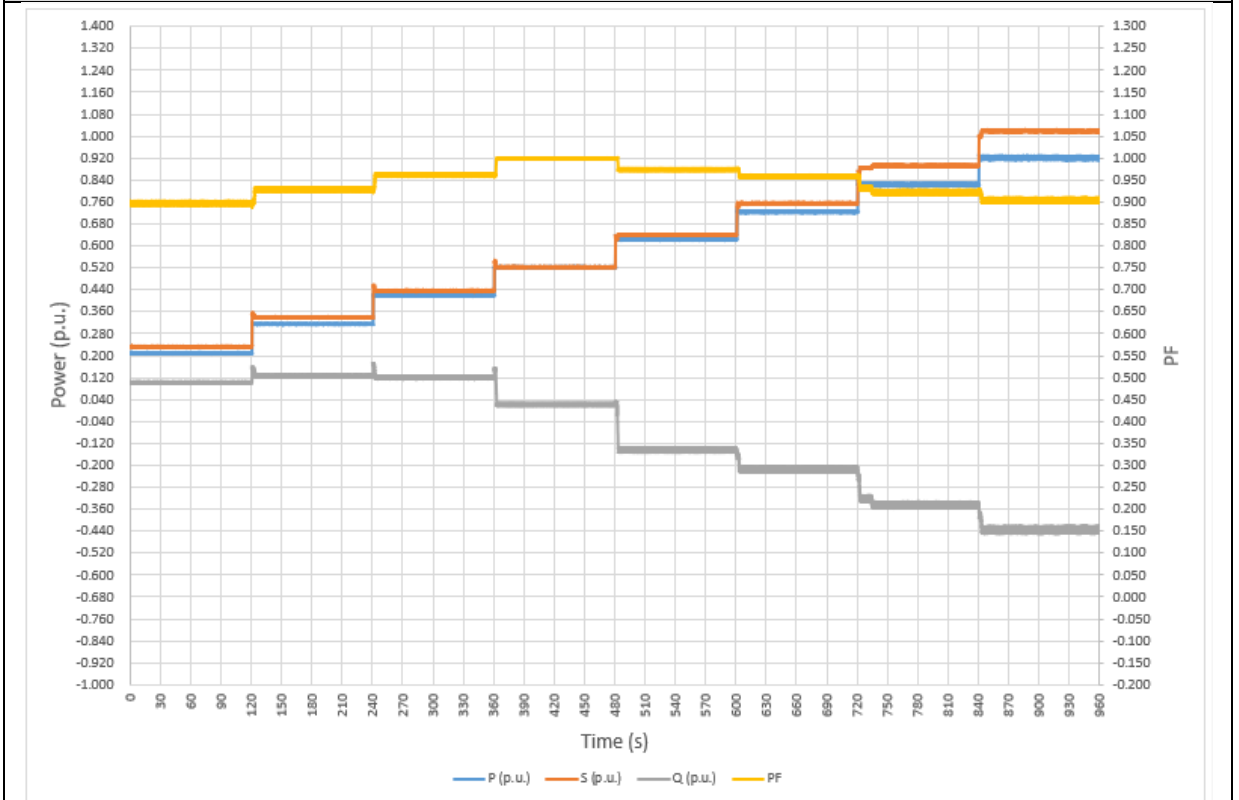

4.13.3.3 Test 3

In this test it is verified that the power factor varies linearly from PF = 0.95 (inductive) at 20 %Pn to PF = 0.95 (capacitive) at 80 %Pn. The following table shows the obtained test results:

P Desired (%Sn)	P measured (%Sn)	Q measured (%Sn)	Power Factor desired (cos φ)	Power Factor measured (cos φ)	Power Factor Deviation (cos φ)
20	20.9	7.0	0.950	0.947	-0.003
30	31.4	7.6	0.967	0.972	0.005
40	42.0	7.5	0.988	0.984	-0.004
50	52.2	2.3	1.000	0.999	-0.001
60	62.4	-11.2	0.983	0.984	0.001
70	72.4	-19.3	0.967	0.966	-0.001
80	82.4	-27.3	0.950	0.949	-0.001
90	92.4	-30.4	0.950	0.950	0.000

Characteristic curve Cos φ (P) Test 3

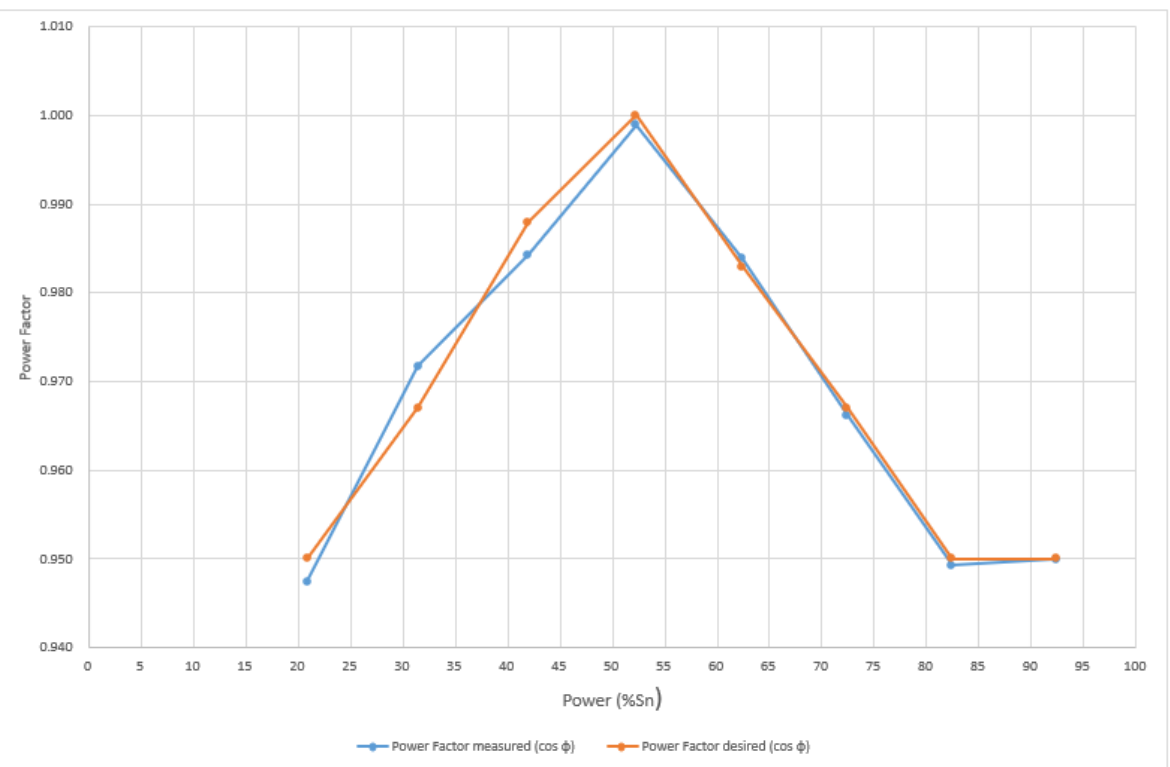
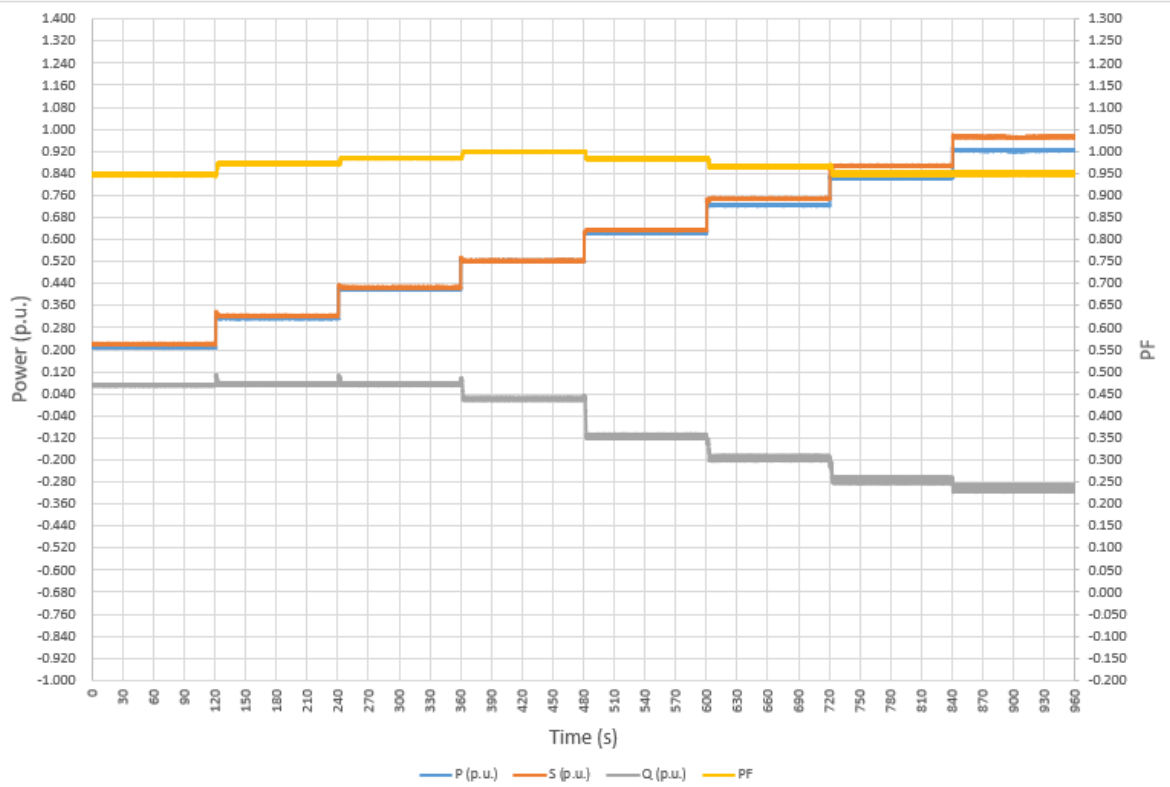

4.13.4.1 Power rate limit

According to the Clause 6.3.5 of the standard, the equipment shall have the capability to gradually increase its output power when requested.

The maximum NL (Nonlinearity) shall be less 10% according to standard.

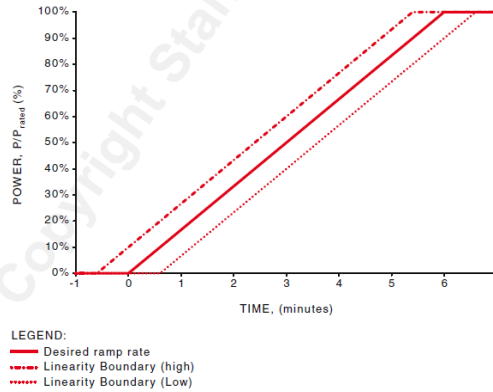

Gradients have ability to set from 4 %P_n/min to 100 %P_n/min by the control system of the inverter. Test results are offered in the table and pictures below:

Increase of Active Power			
Gradient (ΔP) desired (%P _n /min)	Nominal Ramp Time (s)	Gradient measured (%P _n /min)	Measured Ramp time (s)
4	1500	4.0	1497
16.7	360	16.9	354
100	60	100.0	60

Increase of Active Power with 4 %Pn/min

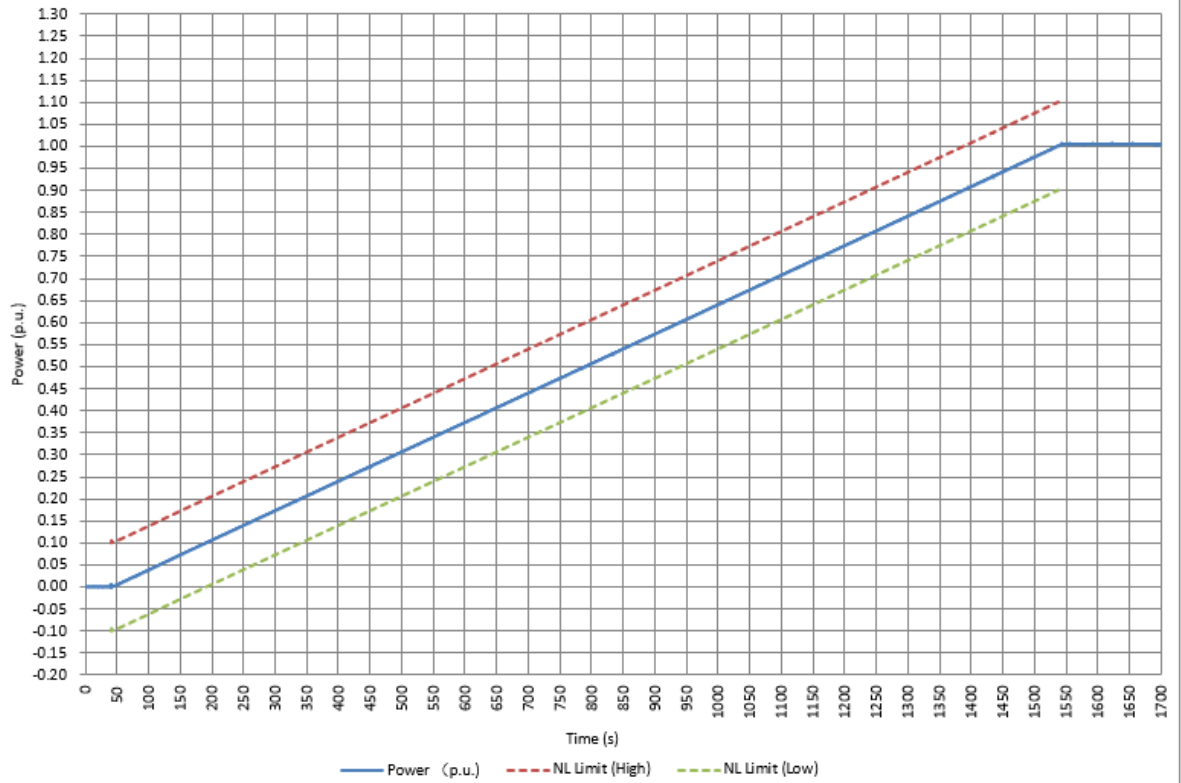

Increase of Active Power with 16.67 %Pn/min

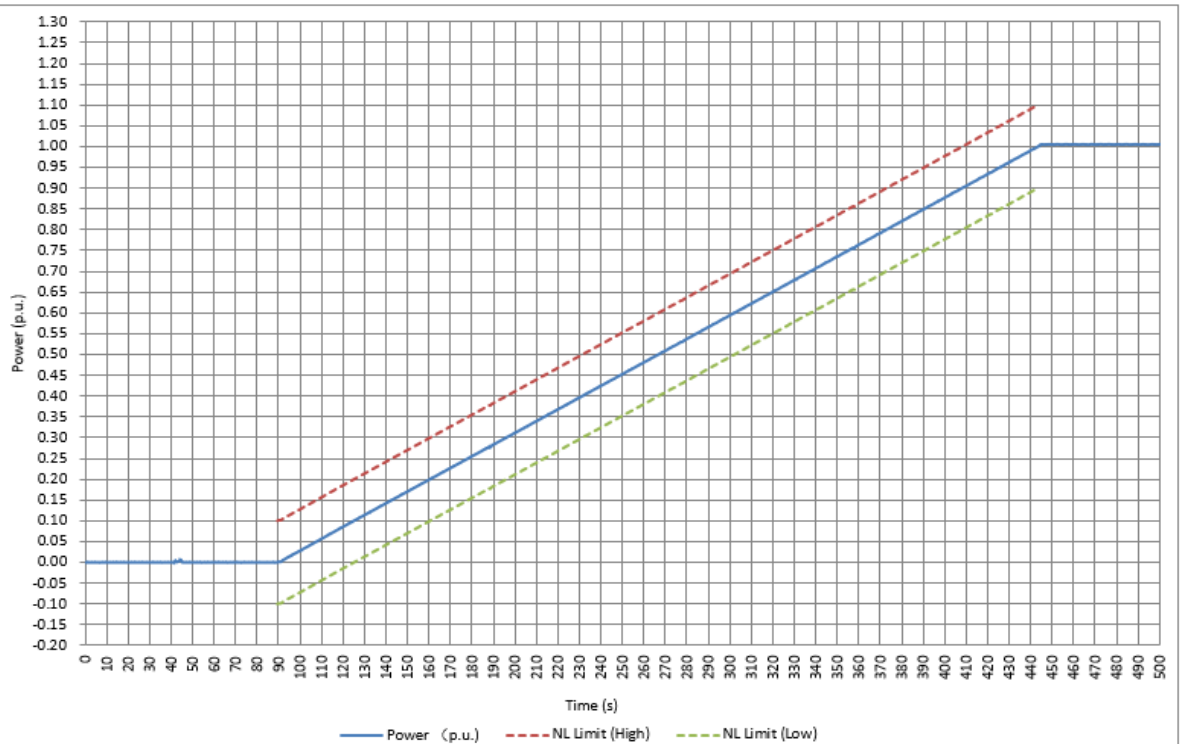

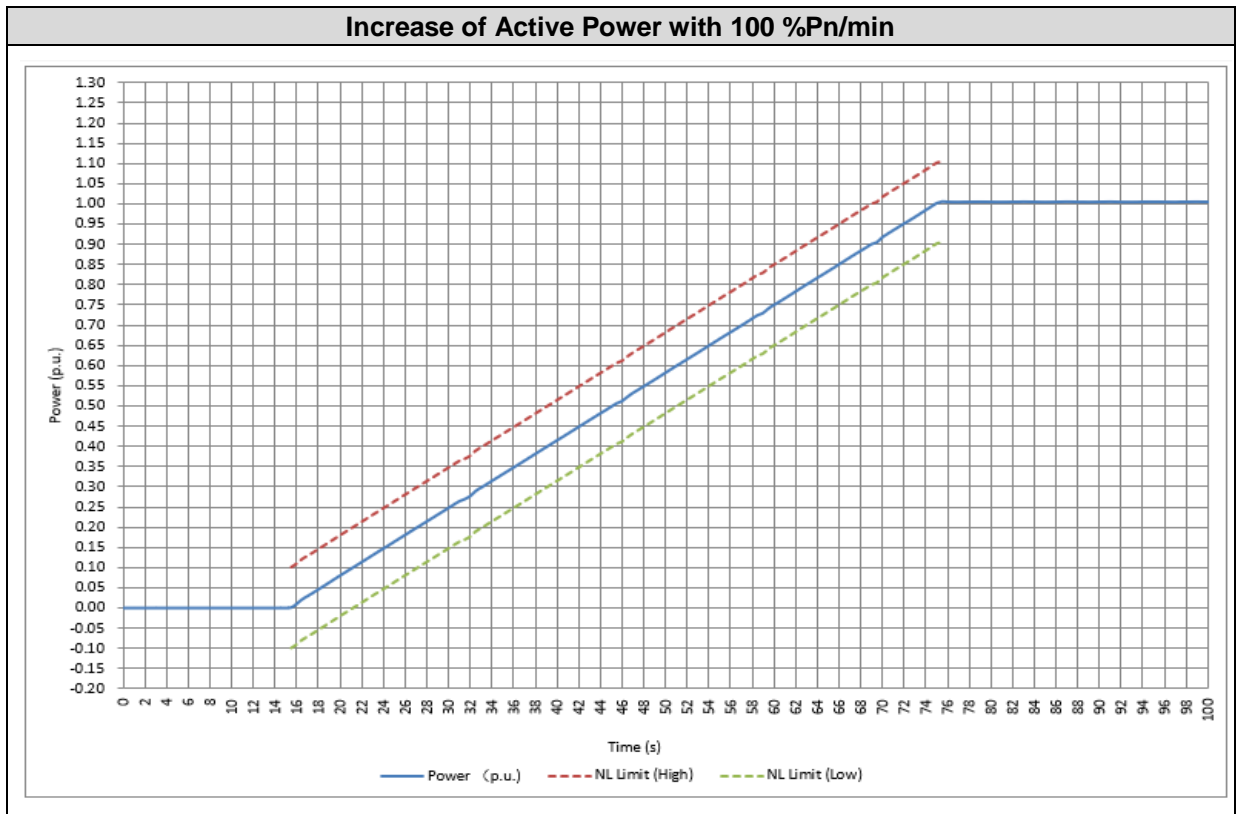

4.13.4.2 Changes in a.c. operation and control

Test is waived due to unit cannot operate at stand-alone mode.

4.13.4.3 Changes in energy source operation

Test is waived due to the inverter is not energy storage.

4.14 MULTIPLE MODE INVERTER OPERATION

4.14.1 Sinusoidal output in stand-alone mode

The a.c. output voltage waveform of a stand-alone port of a multiple mode inverter operating in stand-alone mode, shall comply with the requirements of this Clause (6.4.2). The a.c. output voltage waveform of a stand-alone mode shall have a voltage total harmonic distortion (THD) not exceeding 5% and no individual harmonic at a level exceeding 5%.

Compliance shall be checked by measuring the THD and the individual harmonic voltages with the inverter delivering 5% power or the lowest continuous available output power greater than 5%, and 50% and 100% of its continuous rated power, into a resistive load, with the inverter supplied with nominal d.c. input voltage. The THD measuring instrument shall measure the sum of the harmonics from $n = 2$ to $n = 50$ as a percentage of the fundamental ($n = 1$) component at each load level.

Test is waived due to the inverter cannot operate at stand-alone mode.

4.14.2 Volt-watt response mode for charging of energy storage

The volt-watt response mode for charging of energy storage varies the power input of the inverter from the grid in response to the voltage at its grid-interactive port. A multiple mode inverter with energy storage which can be charged from the grid shall have this volt-watt response mode. This volt-watt response mode is only active when power from the grid is required to charge the energy storage.

Test is waived due to the inverter is not energy storage.

4.15 SECURITY OF OPERATIONAL SETTINGS

According to the Clause 6.5 of the standard, it has been verified by inspection that changes to the internal setting may require the use of a tool and special instructions not provided to unauthorized personnel.

4.16 AUTOMATIC DISCONNECTION DEVICE

It has been verified that the automatic disconnection device meets the requirements stated in the Clause 7.2 of the standard.

This automatic disconnection device is in compliance with the following points:

- Is capable to withstand an impulse voltage that could occur at the point of installation and has the appropriate contact gap.
- It doesn't indicate falsely that contacts are open.
- It is installed and designed to prevent unintentional closure that can be caused by events such as impacts or vibration.
- It has devices that disconnects on all live conductors (active and neutral) of the inverter from the grid.
- It is ensured that in case of single fault, there is simple separation.
- It is ensured that in case of single fault, power is prevented to entering the grid.
- It is capable of interrupting the rated current of the equipment.
- The settings of the automatic disconnection don't exceed the capability of the inverter.
- There are not used solid-state semiconductors for isolation purposes.

4.17 ACTIVE ANTI-ISLANDING PROTECTION

Test performed according to IEC 62116. The method used to provide active anti-islanding is frequency instability.

It has been done three different tests,

- Test A (Active Power $>90\%P_n$ and Input Voltage $>75\%V_{dc}$)
- Test B (Active Power $50-66\%P_n$ and Input Voltage $50\pm 10\%V_{dc}$)
- Test C (Active Power $25-33\%P_n$ and Input Voltage $<20\%V_{dc}$)

The maximum trip time is 2 s.

Note: In the tables below, M (%) and N (%) are respectively referred to active and reactive power impedance variation as percentage.

4.17.1 Test A

Balanced Load		
M (%)	N (%)	Disconnection (ms) (limit at t=2s)
-5	+5	340
-5	0	422
-5	-5	308
0	+5	444
0	0	456
0	-5	404
+5	+5	328
+5	0	434
+5	-5	350

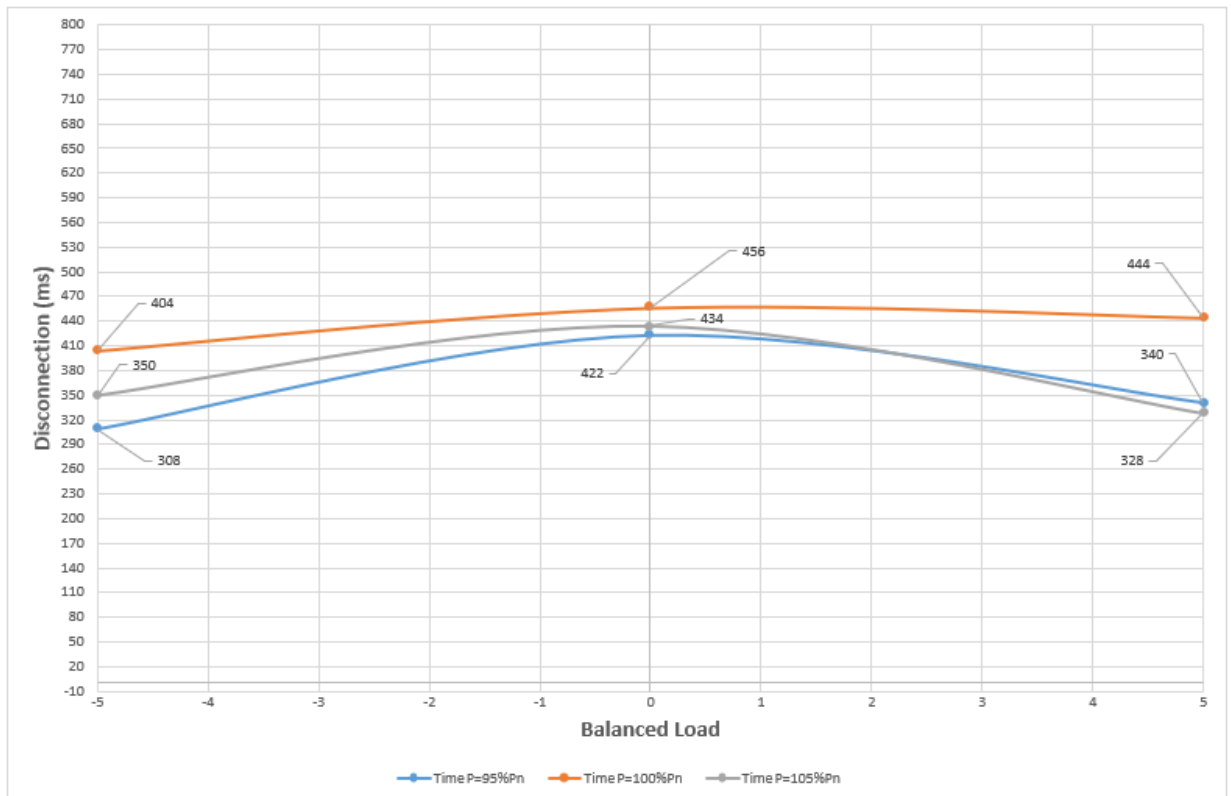

4.17.2 Test B

Balanced Load		
M (%)	N (%)	Disconnection (ms) (limit at t=2s)
0	-5	308
0	-4	328
0	-3	330
0	-2	344
0	-1	314
0	0	412
0	1	364
0	2	332
0	3	398
0	4	350
0	5	328

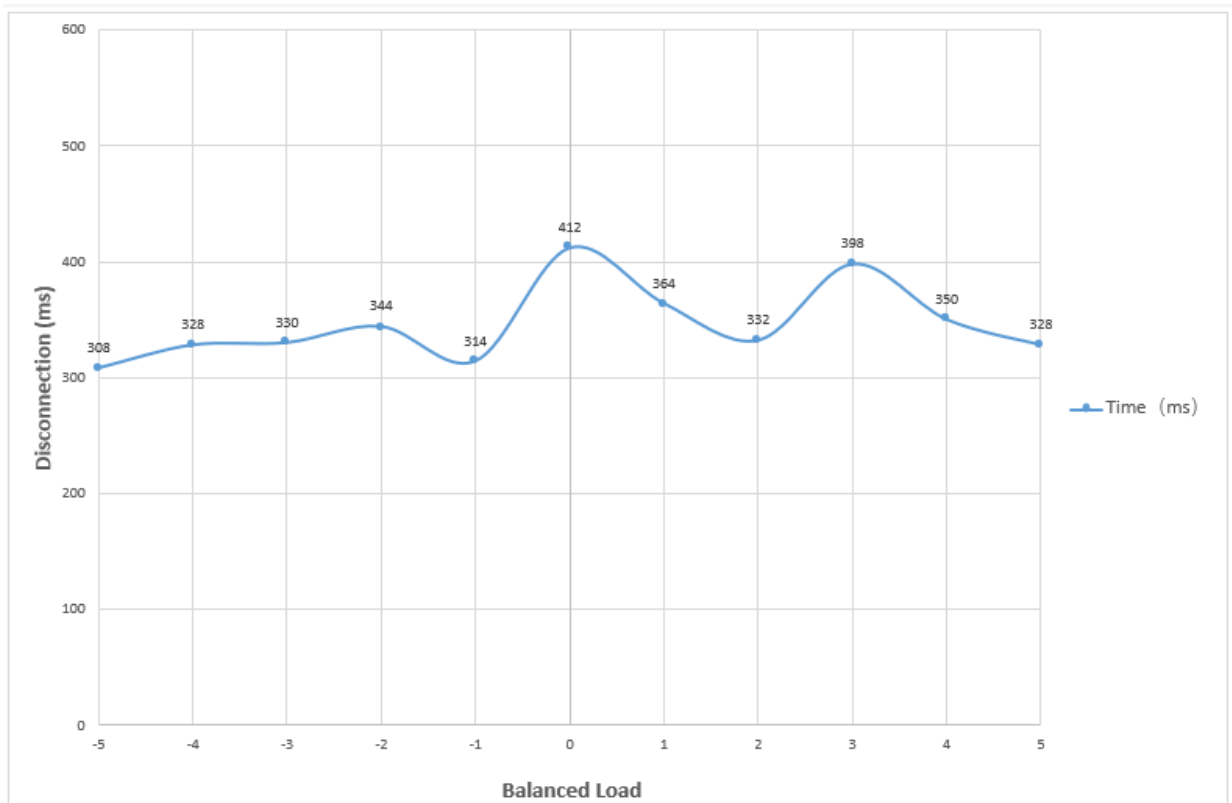

4.17.3 Test C

Balanced Load		
M (%)	N (%)	Disconnection (ms) (limit at t=2s)
0	-5	310
0	-4	348
0	-3	346
0	-2	352
0	-1	348
0	0	376
0	1	360
0	2	408
0	3	374
0	4	380
0	5	362

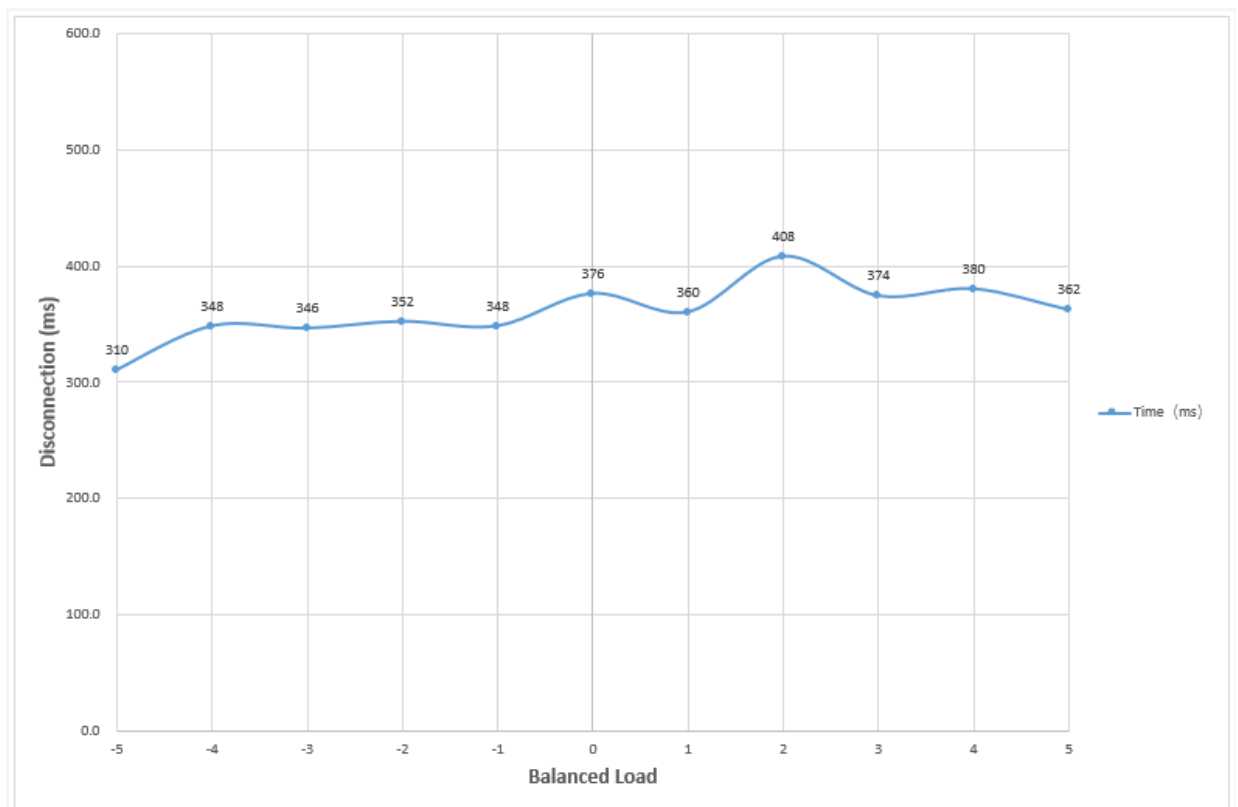

4.18 VOLTAGE AND FREQUENCY LIMITS (PASSIVE ANTI-ISLANDING PROTECTION)

Voltage and frequency limits (Passive Anti-islanding Protection) have been verified according to the Clause 7.4 of the standard.

The inverter should remain in continuous and uninterrupted operation for voltage and frequency variations with duration shorter than the trip delay time specified in the next table:

Protective function	Protective function limit	Trip delay time	Maximum disconnection time
Undervoltage (V<)	180 V	1 s	2 s
Overvoltage 1 (V>)	260 V	1 s	2 s
Overvoltage 2 (V>>)	265 V	—	0.2 s
Under-frequency (F<)	47 Hz (Australia) 45 Hz (New Zealand)	1 s	2 s
Over-frequency (F>)	52 Hz	—	0.2 s

Voltage limits stated by the standard have been expressed as a percentage of 230V and applied to the rated values of the family of inverters contemplated in this report. Each test has been repeated 3 times.

Following indications shall be taken into account to for test results offered in this point.

For trip tests evaluation it is considered the time from when the voltage or frequency, as proceed, is stabilized at the setting value to the instant when the inverter is effectively disconnected and with no current.

For frequency trip tests evaluation, in order to have a bigger accuracy it has been evaluated and represented the first period of the sine wave where the frequency surpasses the frequency limit and from that first period has been evaluated the tripping time.

For these cases, a second graph representing the “trip value” is offered. In them cursors are allocated among the beginning and the end of a period of the voltage sine wave, measuring the time that lasts the whole period and allowing calculating the frequency of the period.

4.18.1 Voltage trip tests

To assess that the protective function of the inverter against abnormal voltage is effective two different kinds of tests have been done:

- Trip value tests to evaluate if the inverter can trip with accuracy in accordance with a settling value of voltage.
- Trip time tests to evaluate if the inverter can trip into the limits of time stated by the standard in case of detecting voltage levels out of the limits stated.

The standard states that the tolerance limit for voltage trip values is ± 2 V, which is a 0.8 %Un over 230 V, the reference voltage considered by the standard. So, 0.8 %Un is the allowed tolerance to be considered for voltage trip value tests.

4.18.1.1 Voltage trip value tests

The tests have been made as the following procedure:

- For undervoltage protection ($U<$): Starting from a voltage level 1 %Un above the trip value of the protection function to be tested, the voltage is decreased 1 V in steps of at least 5 seconds.
- For overvoltage protection ($U>$): Starting from a voltage level 1 %Un below the trip value of the protection function to be tested, the voltage is increased 1 V in steps of at least 5 seconds.
- For overvoltage protection ($U>>$): Starting from a voltage level 1 %Un below the trip value of the protection function to be tested, the voltage is increased 1 V in steps of at least 5 seconds. Disable overvoltage protection ($U>$) function during the test.

Test results are offered in the following table:

Protective Function Tested	No Trip Test			Trip Test		
	Start Voltage value (%Un)	Time measured per step (s)	Trip	Voltage Trip settling value (%Un)	Trip	Voltage trip value measured (%Un)
U < (Rep 1)	79.5%	>5.00	<input checked="" type="checkbox"/> NO <input type="checkbox"/> YES	78.3%	<input type="checkbox"/> NO <input checked="" type="checkbox"/> YES	78.2%
U < (Rep 2)	79.5%	>5.00	<input checked="" type="checkbox"/> NO <input type="checkbox"/> YES	78.3%	<input type="checkbox"/> NO <input checked="" type="checkbox"/> YES	78.1%
U < (Rep 3)	79.5%	>5.00	<input checked="" type="checkbox"/> NO <input type="checkbox"/> YES	78.3%	<input type="checkbox"/> NO <input checked="" type="checkbox"/> YES	78.2%
U > (Rep 1)	112.0%	>5.00	<input checked="" type="checkbox"/> NO <input type="checkbox"/> YES	113.0%	<input type="checkbox"/> NO <input checked="" type="checkbox"/> YES	113.1%
U > (Rep 1)	112.0%	>5.00	<input checked="" type="checkbox"/> NO <input type="checkbox"/> YES	113.0%	<input type="checkbox"/> NO <input checked="" type="checkbox"/> YES	113.2%
U > (Rep 3)	112.0%	>5.00	<input checked="" type="checkbox"/> NO <input type="checkbox"/> YES	113.0%	<input type="checkbox"/> NO <input checked="" type="checkbox"/> YES	113.2%
U >> (Rep 1) (*)	114.0%	>5.00	<input checked="" type="checkbox"/> NO <input type="checkbox"/> YES	115.0%	<input type="checkbox"/> NO <input checked="" type="checkbox"/> YES	115.3%
U >> (Rep 1) (*)	114.0%	>5.00	<input checked="" type="checkbox"/> NO <input type="checkbox"/> YES	115.0%	<input type="checkbox"/> NO <input checked="" type="checkbox"/> YES	115.3%
U >> (Rep 3) (*)	114.0%	>5.00	<input checked="" type="checkbox"/> NO <input type="checkbox"/> YES	115.0%	<input type="checkbox"/> NO <input checked="" type="checkbox"/> YES	115.3%

Maximum deviation allowed in voltage trip value is $\pm 0.8 \%U_n$.

(*) Disable overvoltage protection (U>) function during the test.

Test results are graphically shown in following pages.

Undervoltage (U <) Rep 1

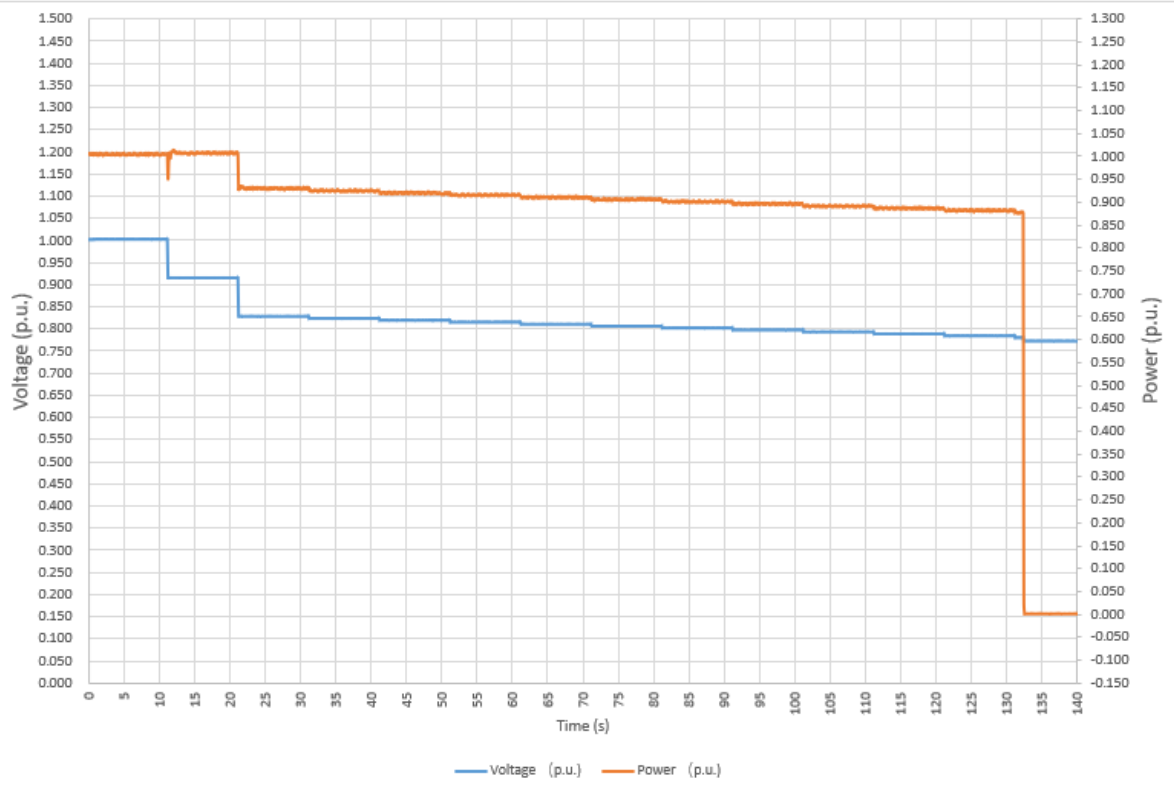

Undervoltage (U <) Rep 2

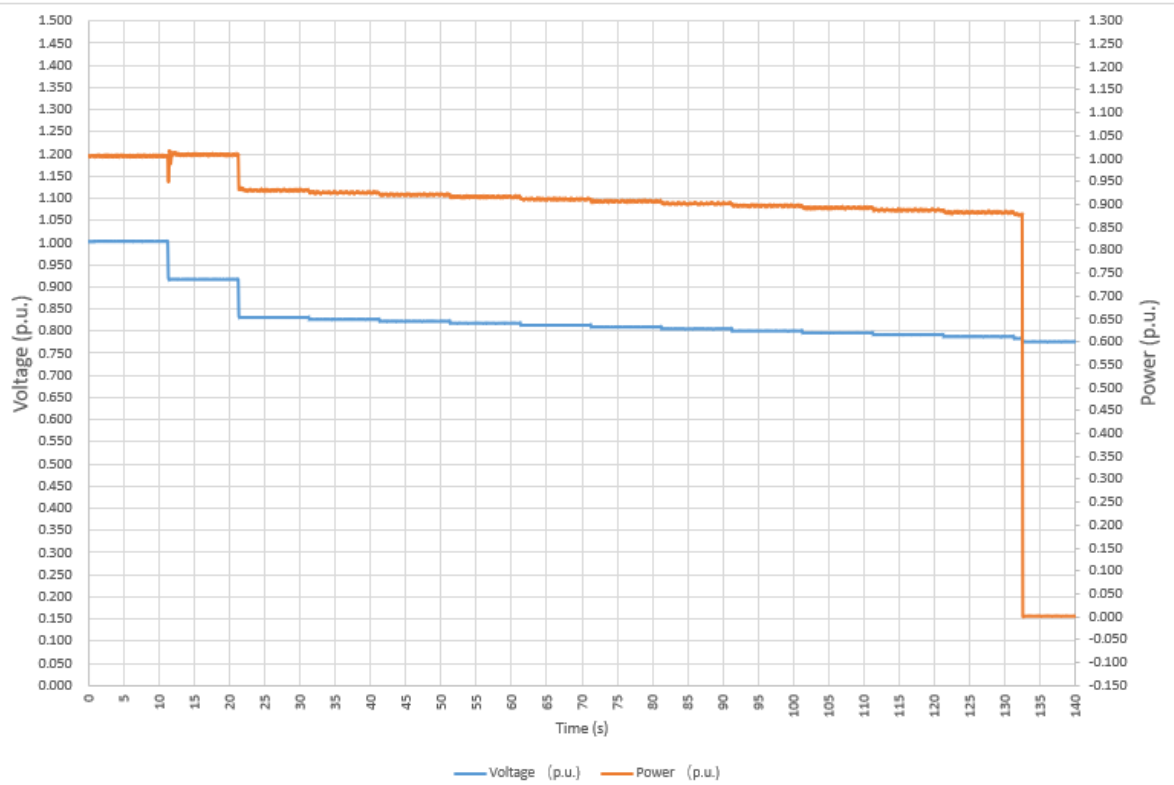

Undervoltage (U <) Rep 3

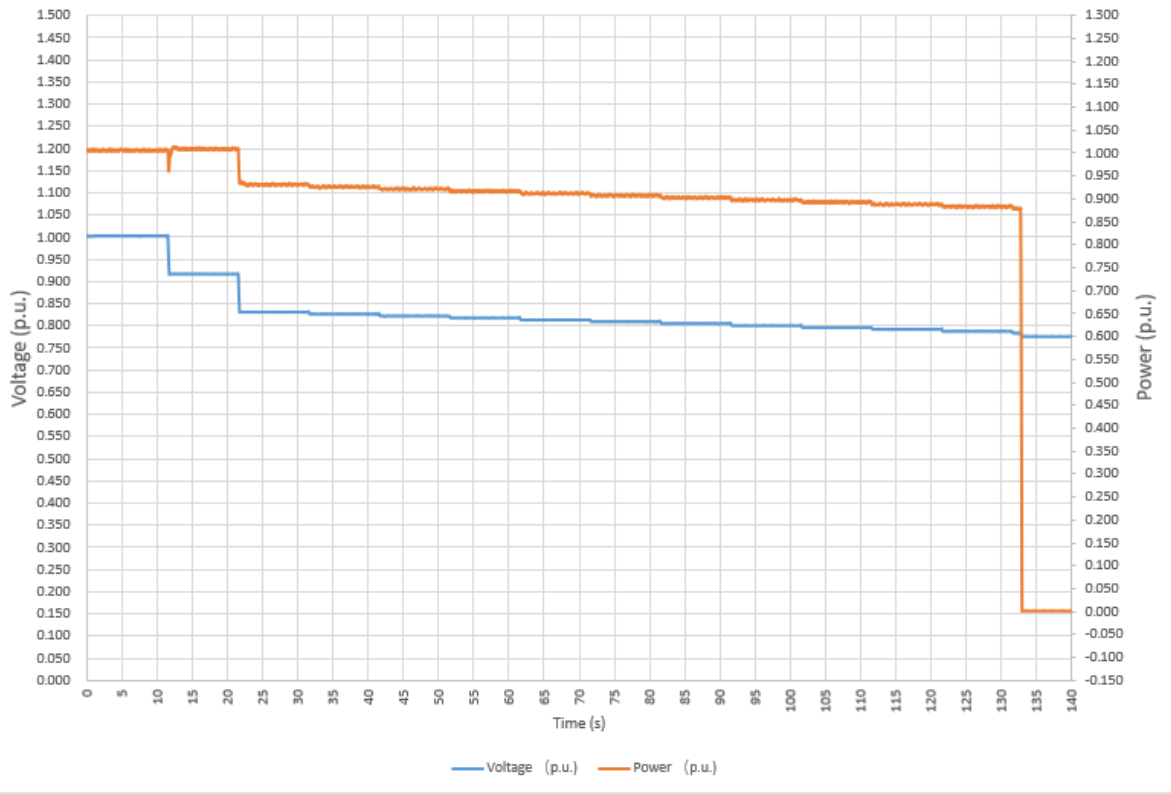

Overvoltage (U >) Rep 1

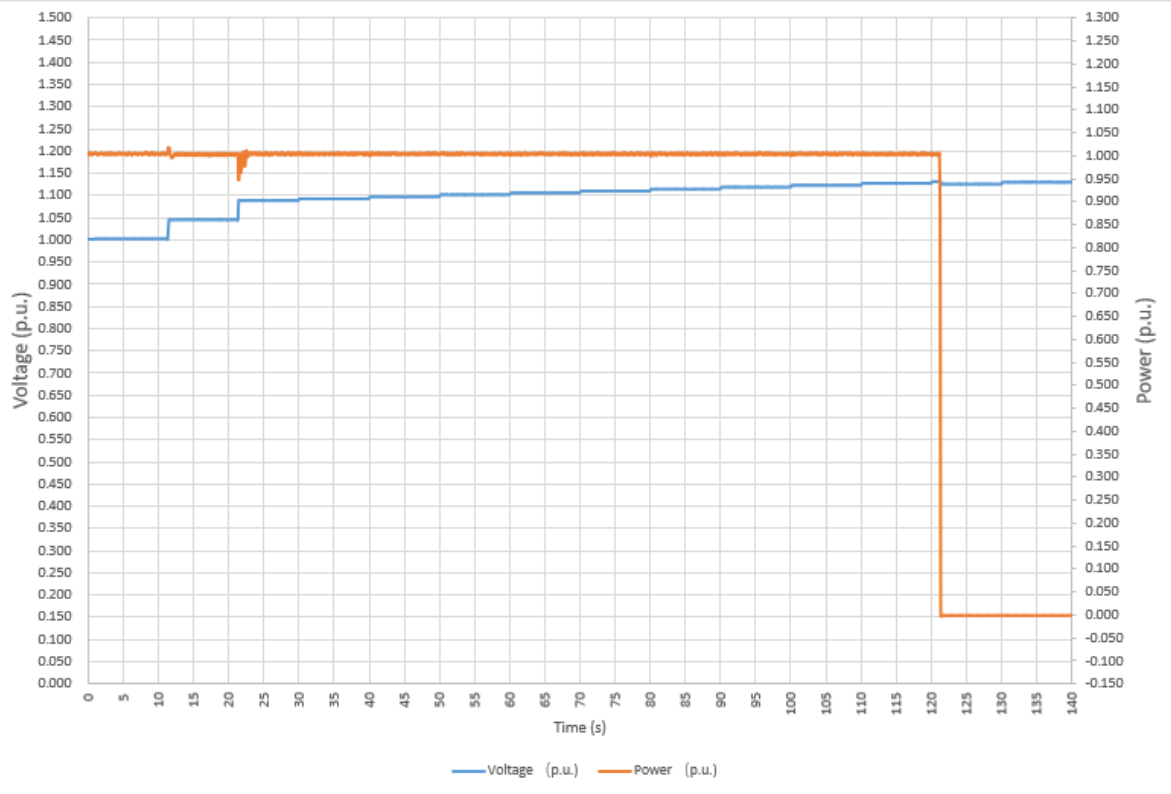

Overvoltage (U >) Rep 2

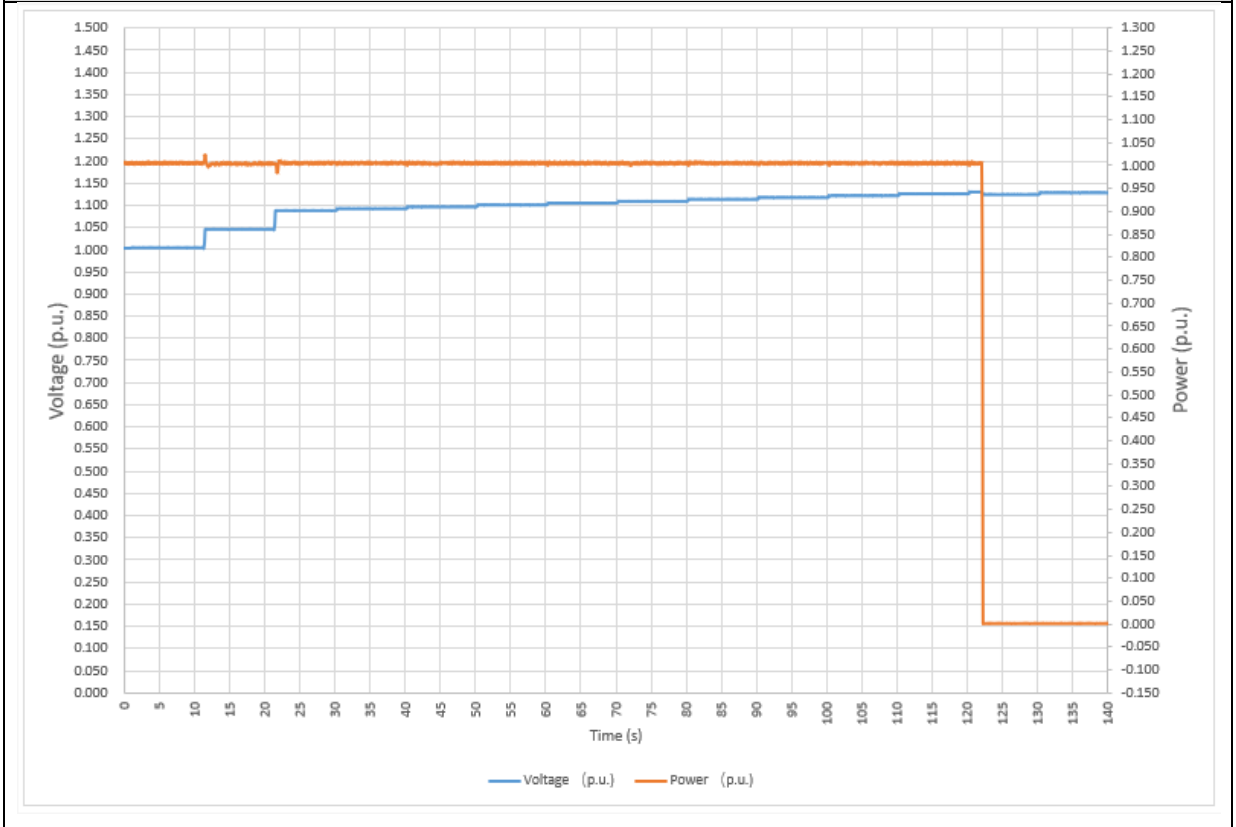

Overvoltage (U >) Rep 3

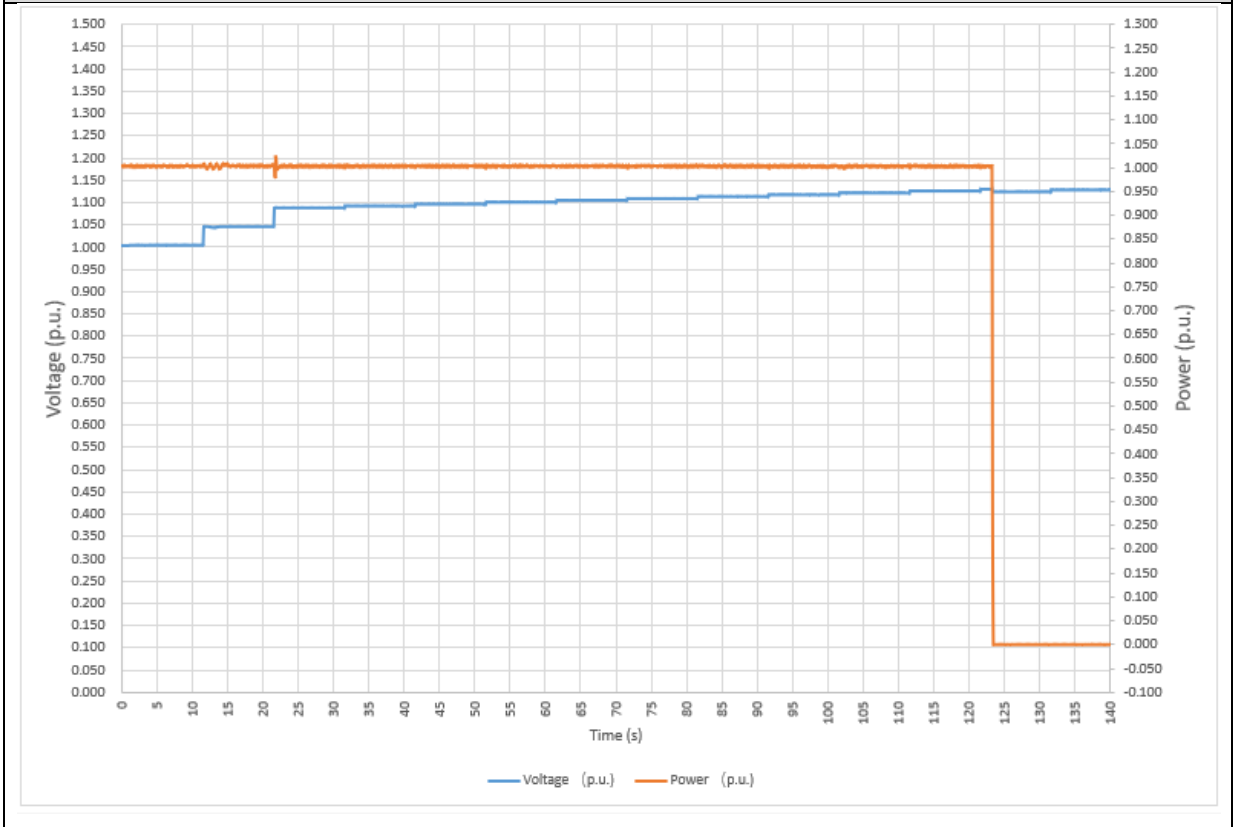

Overvoltage (U >>) Rep 1

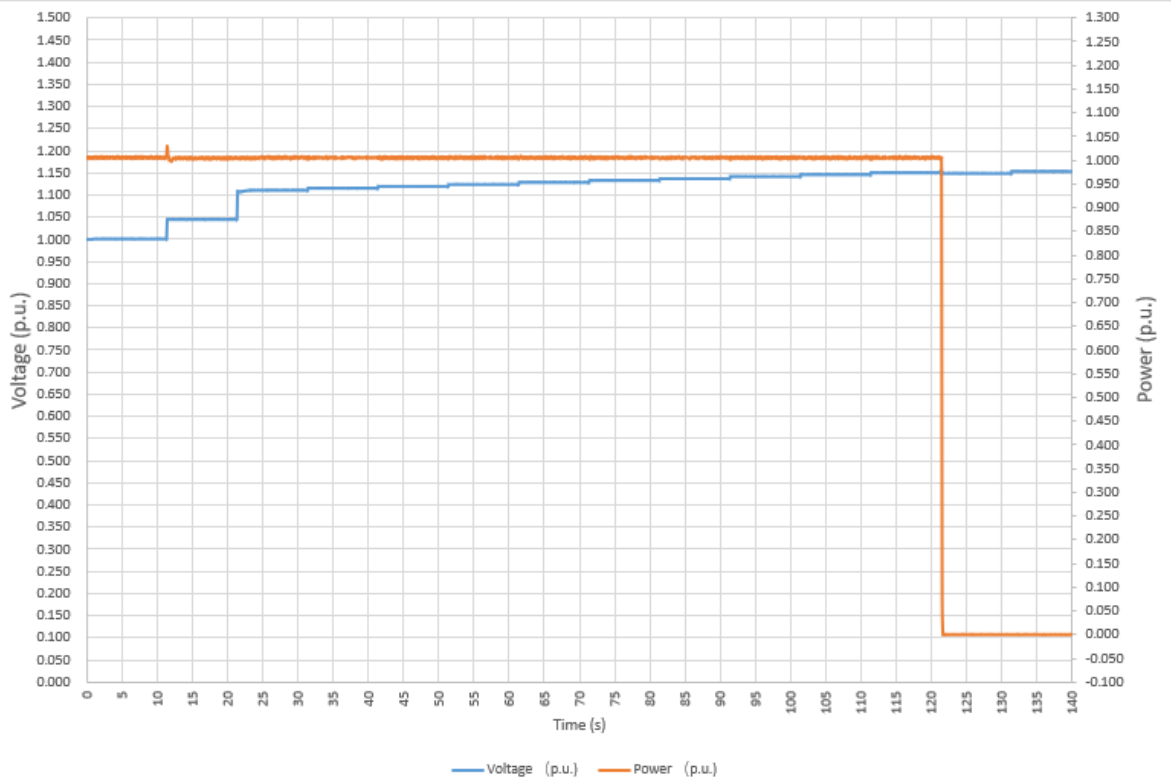

Overvoltage (U >>) Rep 2

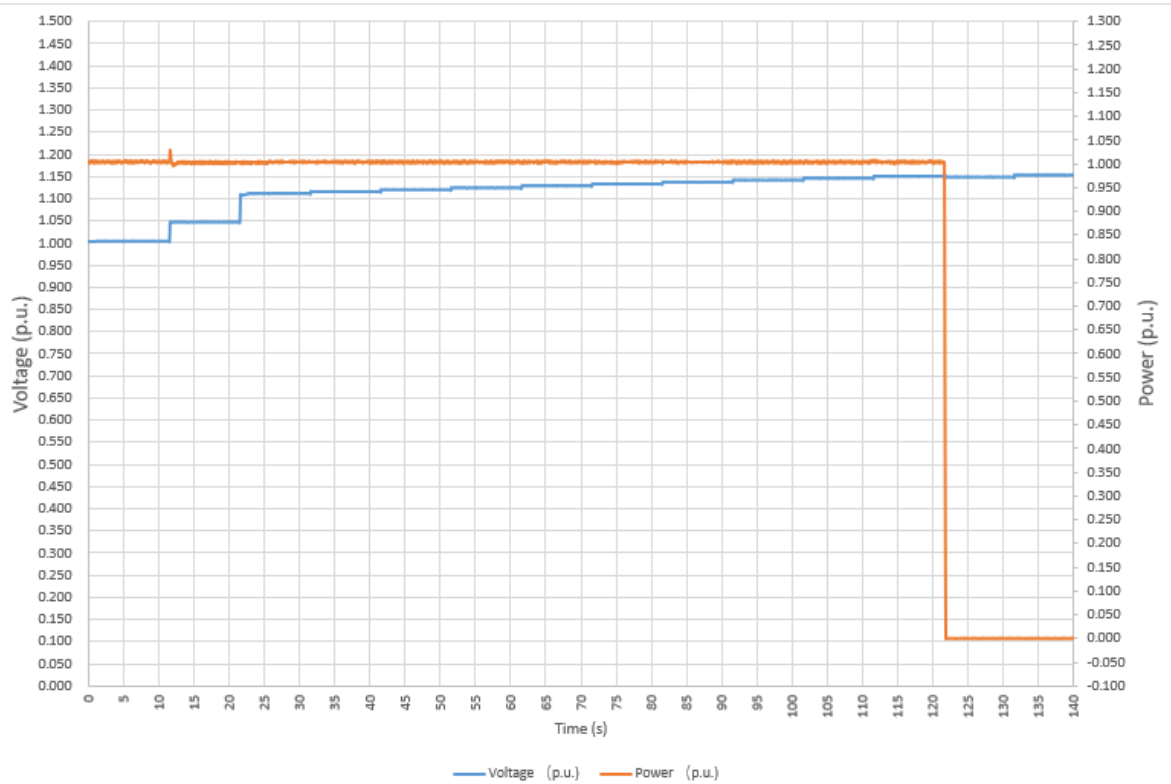

Overvoltage (U >>) Rep 3

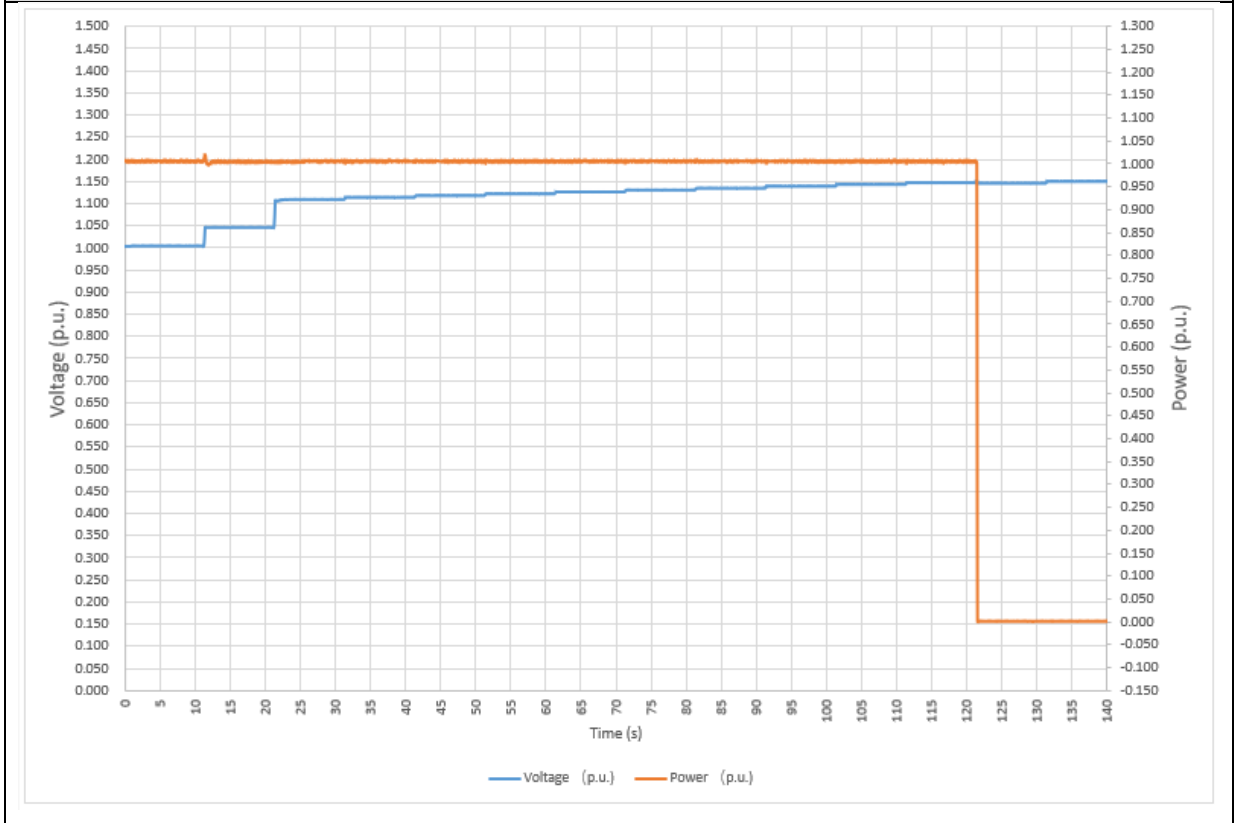

4.18.1.2 Voltage trip time tests

The tests have been made as the following procedure:

- For undervoltage protection (U<): Maintaining the voltage with a value 78.5 %Un during at least 1.5 seconds and then change the voltage to 78.2 %Un with a step. Trip time shall take place in less than 2 seconds and more than 1 s.
- For overvoltage protection (U>): Maintaining the voltage with a value 112.5 %Un during at least 1.5 seconds and then change the voltage to 113.0 %Un with a step. Trip time shall take place in less than 2 seconds and more than 1 s.
- For overvoltage protection (U>>): Maintaining the voltage with a value 114.5 %Un during at least 0.5 seconds and then change the voltage to 115.0 %Un with a step. Trip time shall take place in less than 0.2 seconds.

Test results are offered in the following table:

Protective Function Tested	No Trip Test			Trip Test		
	Voltage value (%Un)	Time measured (s)	Trip	Voltage settling value (%Un)	Trip	Trip time measured (ms)
U < (Rep 1)	78.5	>1.5	<input checked="" type="checkbox"/> NO <input type="checkbox"/> YES	78.2	<input type="checkbox"/> NO <input checked="" type="checkbox"/> YES	1240
U < (Rep 2)	78.5	>1.5	<input checked="" type="checkbox"/> NO <input type="checkbox"/> YES	78.2	<input type="checkbox"/> NO <input checked="" type="checkbox"/> YES	1226
U < (Rep 3)	78.5	>1.5	<input checked="" type="checkbox"/> NO <input type="checkbox"/> YES	78.2	<input type="checkbox"/> NO <input checked="" type="checkbox"/> YES	1238
U > (Rep 1)	112.5	>1.5	<input checked="" type="checkbox"/> NO <input type="checkbox"/> YES	113.0	<input type="checkbox"/> NO <input checked="" type="checkbox"/> YES	1244
U > (Rep 2)	112.5	>1.5	<input checked="" type="checkbox"/> NO <input type="checkbox"/> YES	113.0	<input type="checkbox"/> NO <input checked="" type="checkbox"/> YES	1220
U > (Rep 3)	112.5	>1.5	<input checked="" type="checkbox"/> NO <input type="checkbox"/> YES	113.0	<input type="checkbox"/> NO <input checked="" type="checkbox"/> YES	1230
U >> (Rep 1)	114.5	> 0.5	<input checked="" type="checkbox"/> NO <input type="checkbox"/> YES	115.0	<input type="checkbox"/> NO <input checked="" type="checkbox"/> YES	116
U >> (Rep 2)	114.5	> 0.5	<input checked="" type="checkbox"/> NO <input type="checkbox"/> YES	115.0	<input type="checkbox"/> NO <input checked="" type="checkbox"/> YES	118
U >> (Rep 3)	114.5	> 0.5	<input checked="" type="checkbox"/> NO <input type="checkbox"/> YES	115.0	<input type="checkbox"/> NO <input checked="" type="checkbox"/> YES	114

Test results are graphically shown in the graphs below, in the following pages.

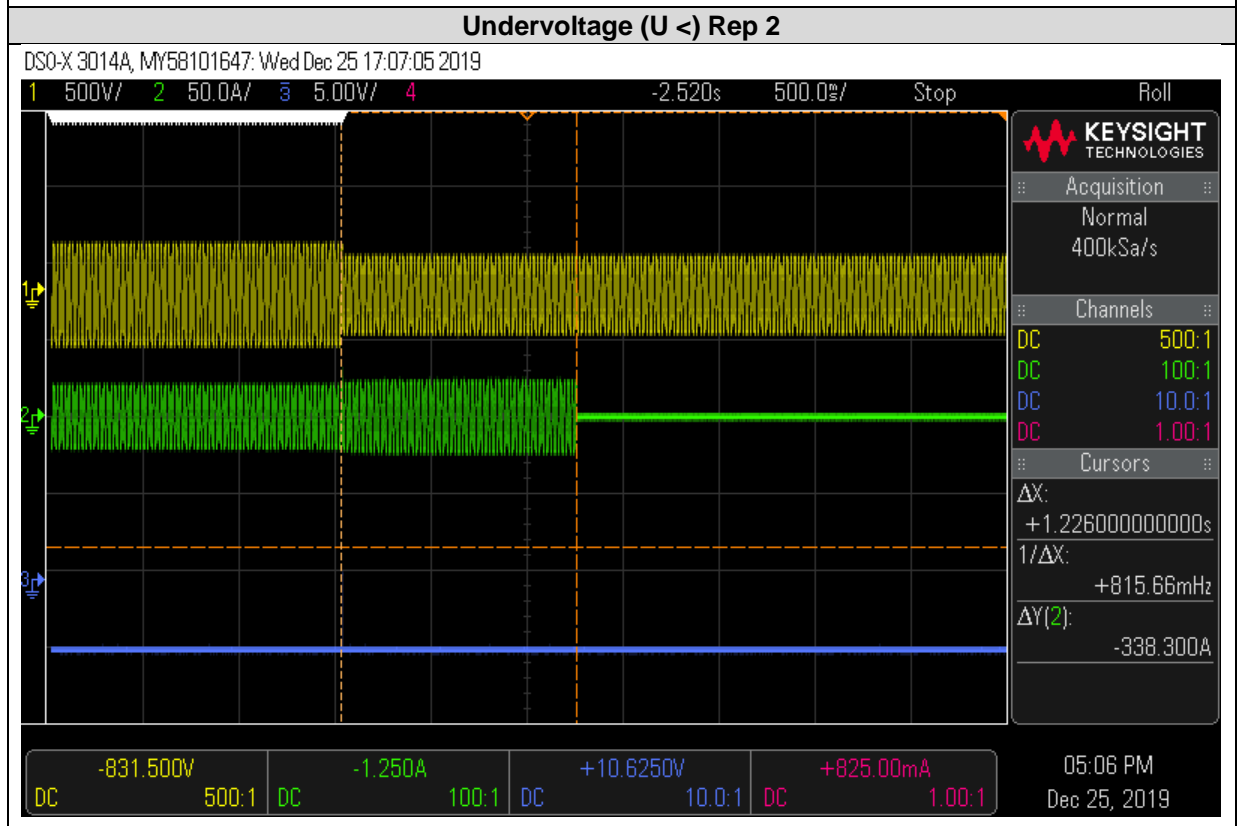
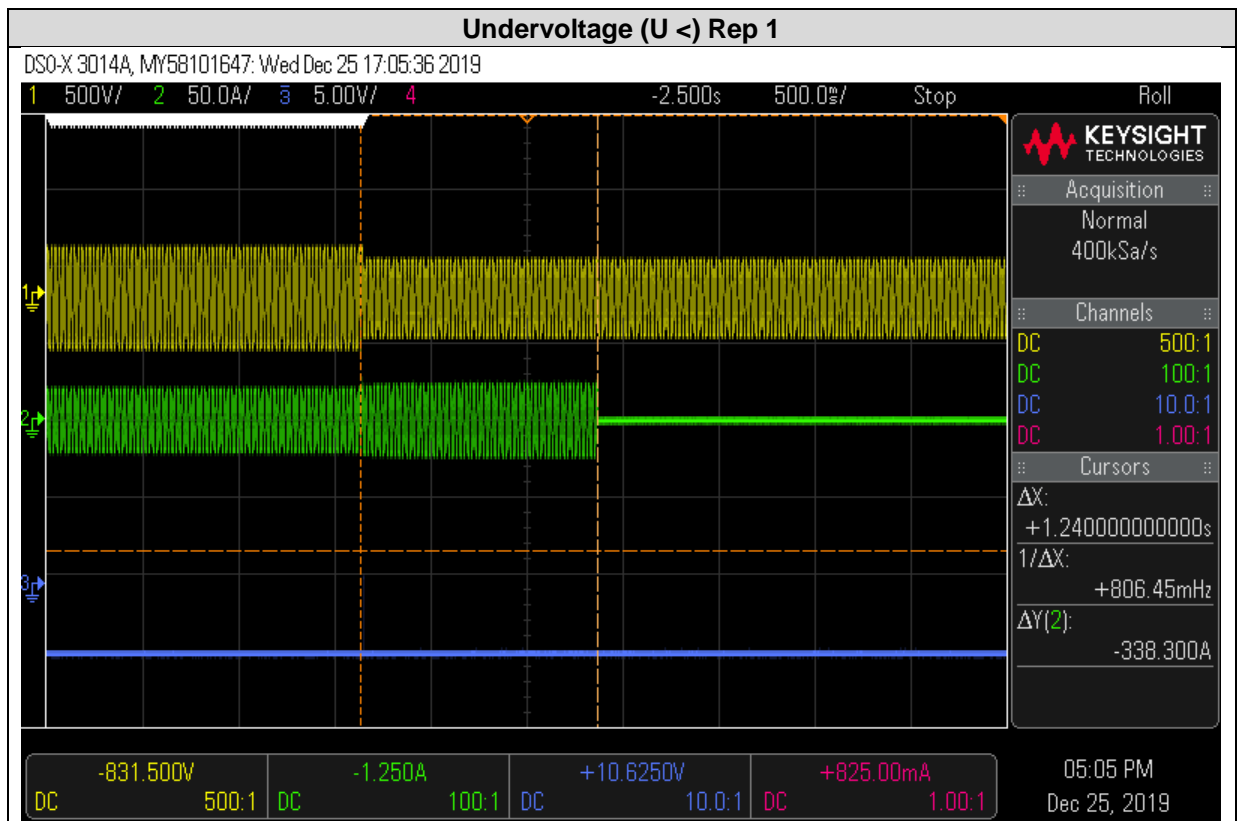

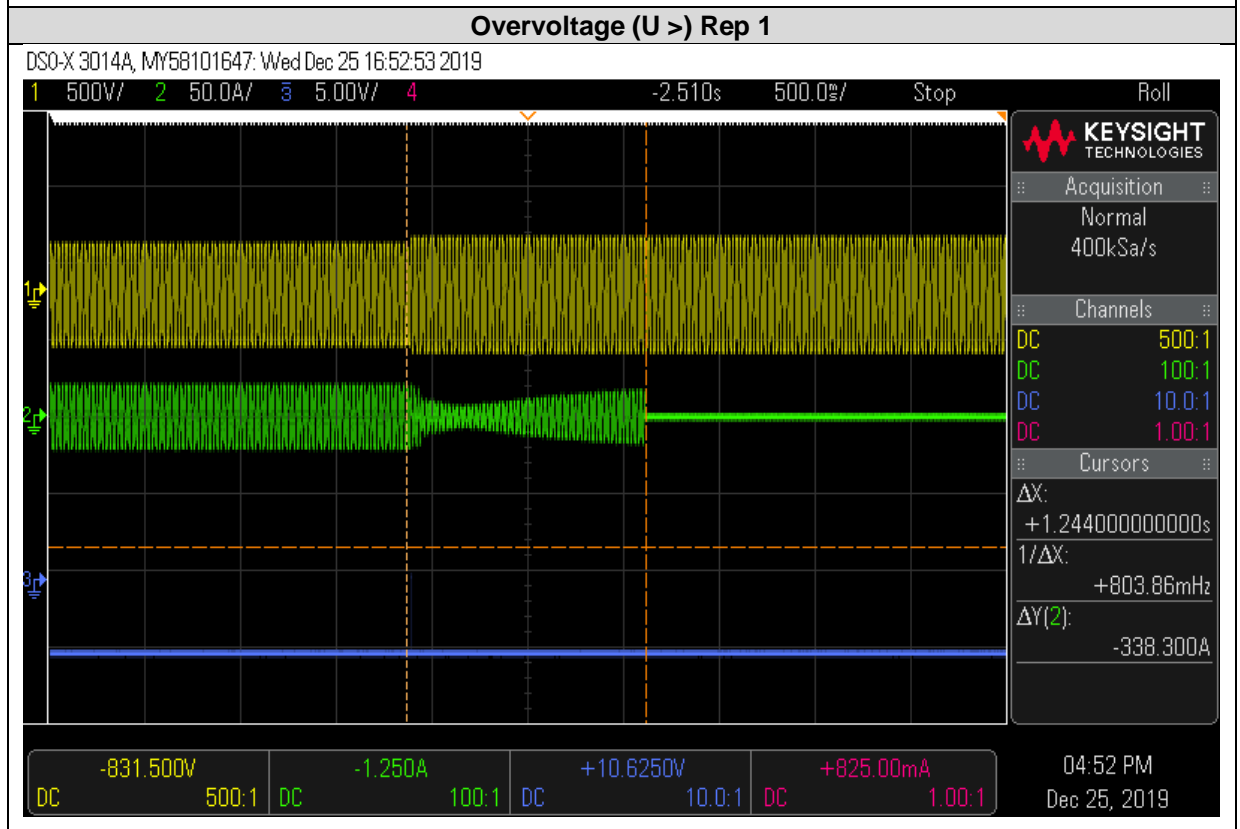
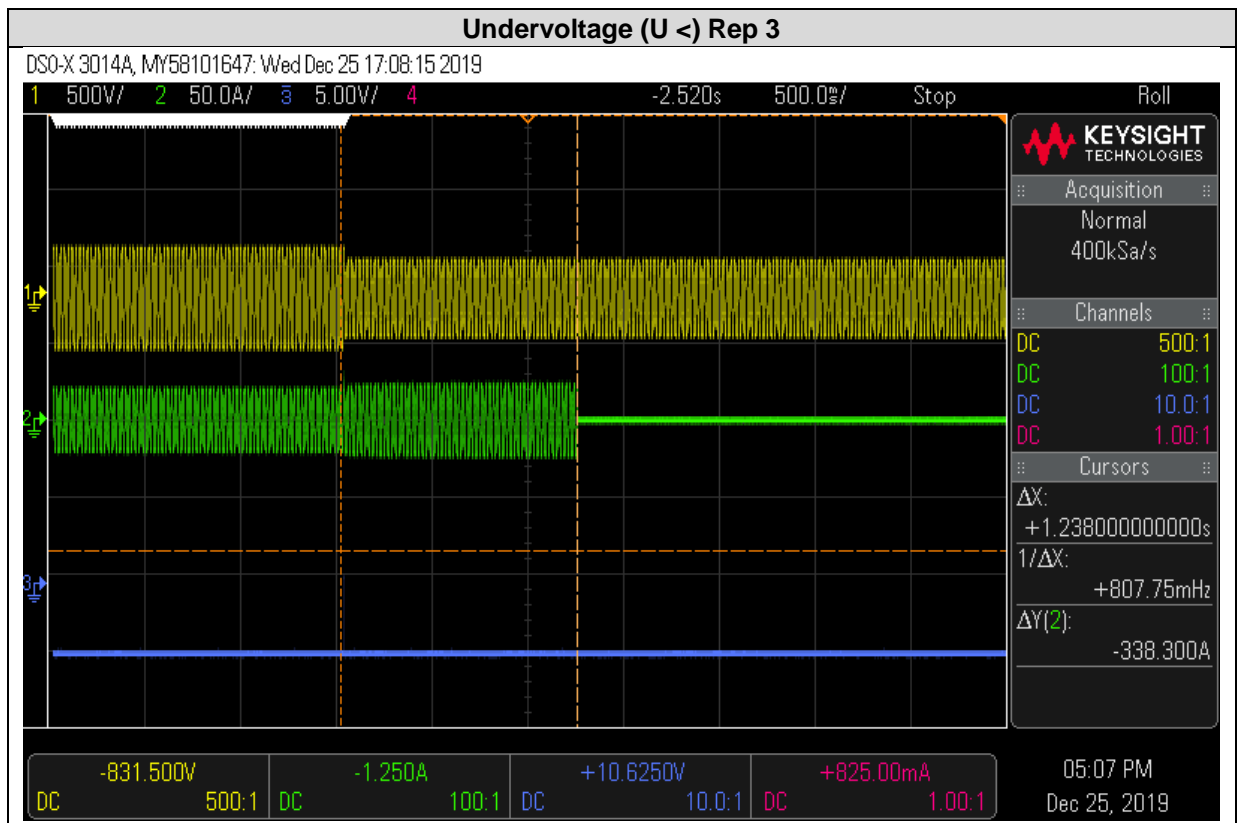

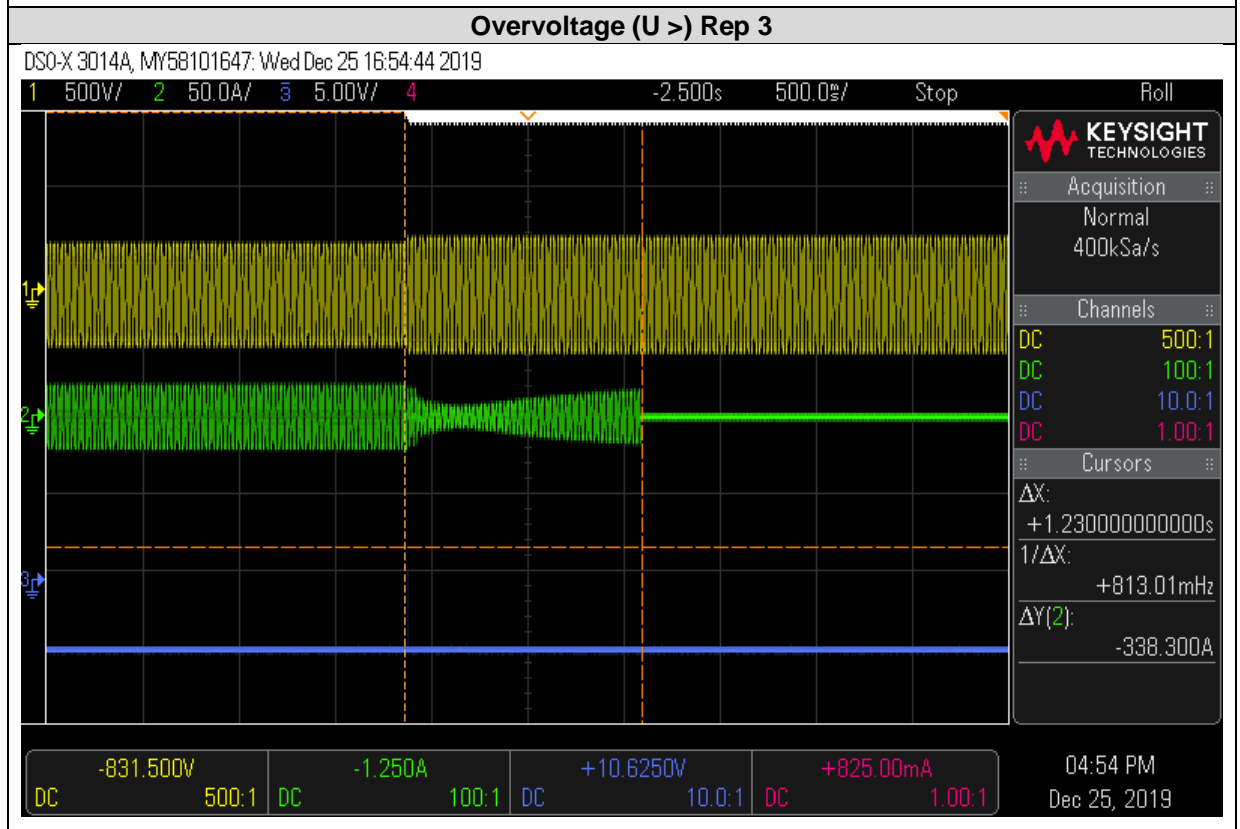
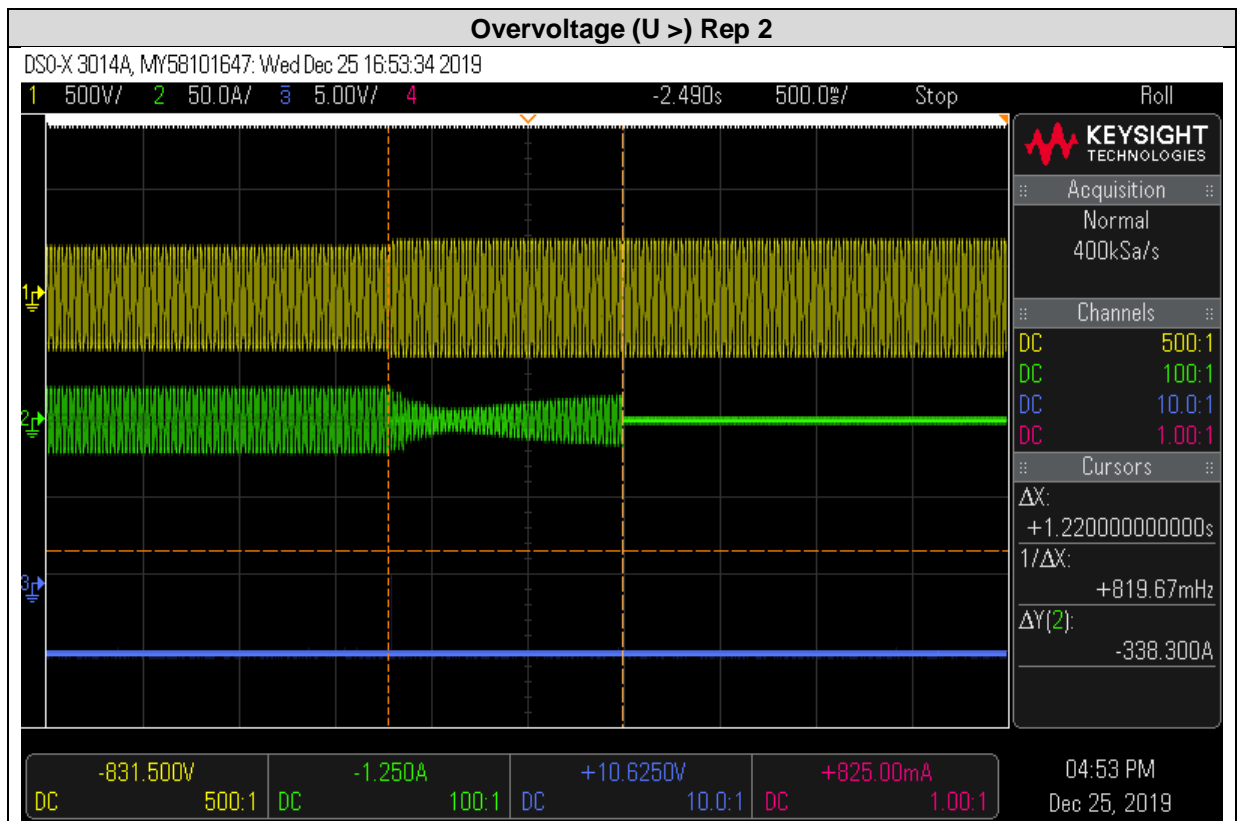

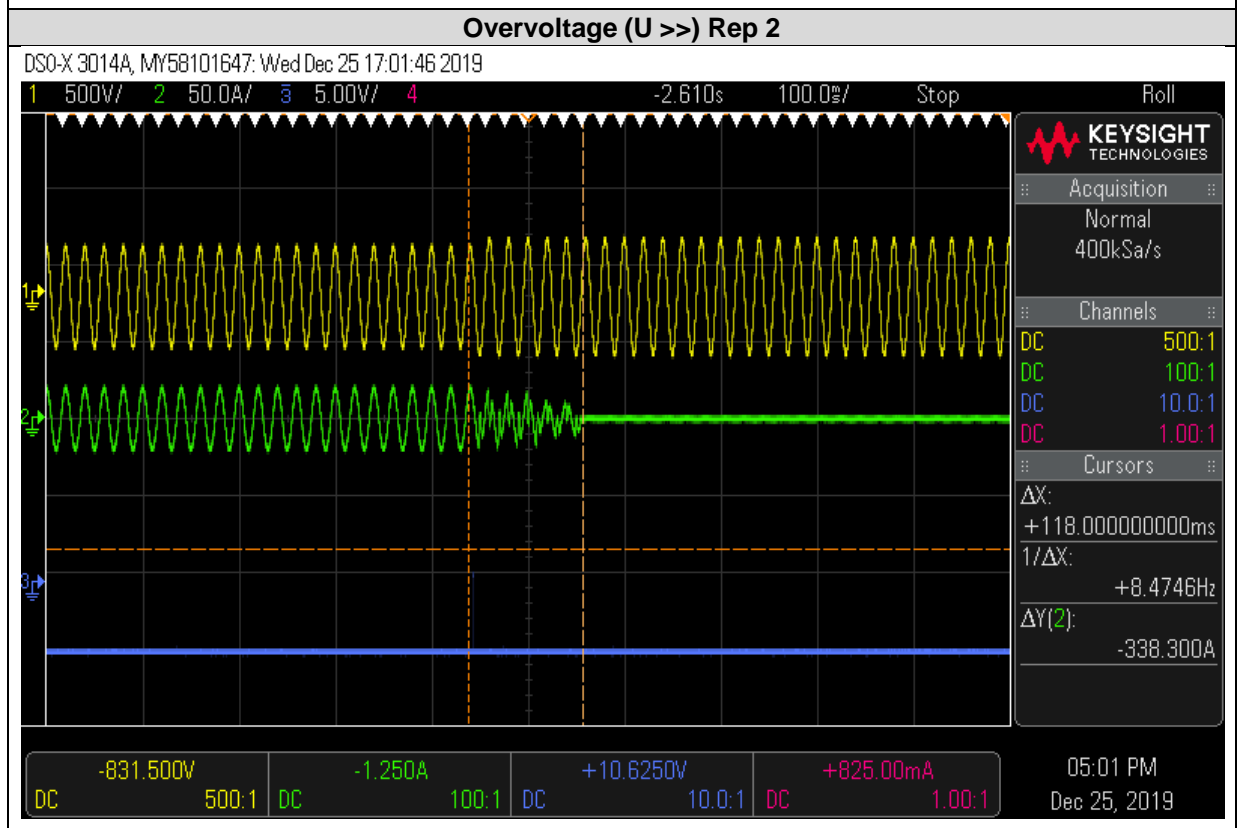
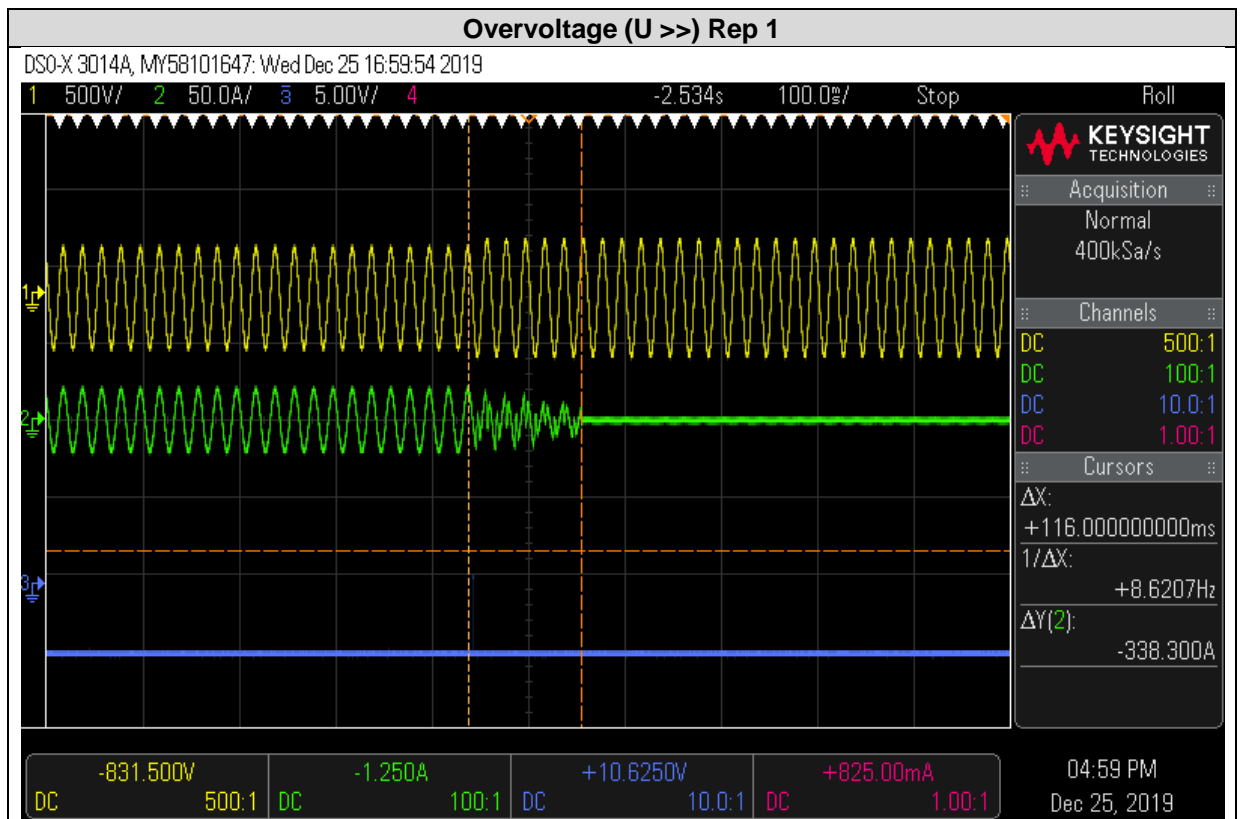

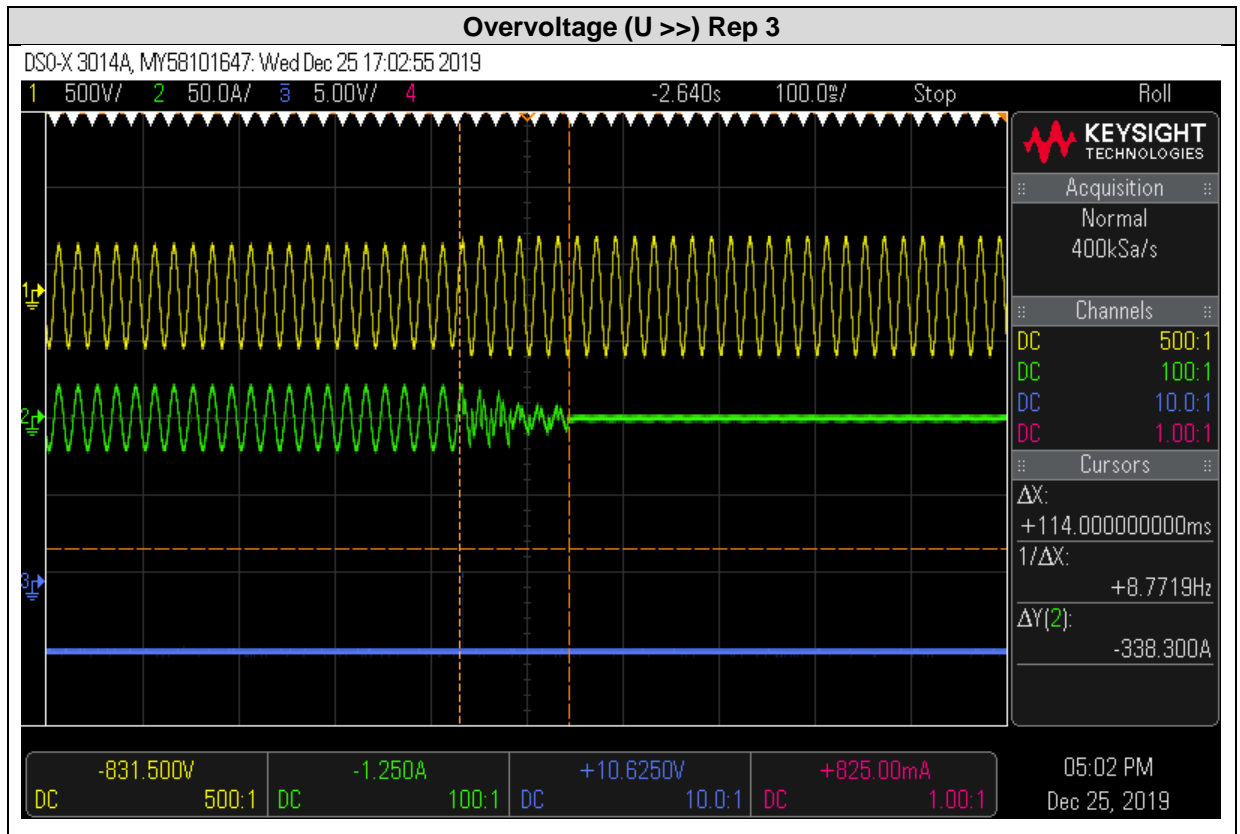

4.18.2 Frequency trip tests

To assess that the protective function of the inverter against abnormal frequency is effective two different kinds of tests have been done:

- Trip value tests, to evaluate if the inverter can trip with accuracy in accordance with a settling value of frequency.
- Trip time tests, to evaluate if the inverter can trip into the limits of time stated by the standard in case of detecting frequency levels out of the limits stated by the standard.

4.18.2.1 Frequency trip value tests

The tests have been made as the following procedure:

- For underfrequency protection: Starting from a frequency level 0.2 Hz above the trip value of the protection function to be tested, the frequency is decreased 0.05 Hz in steps of at least 150% of the trip time delay stated in the protection function to be tested.
- For overfrequency protection: Starting from a frequency level 0.2 Hz below the trip value of the protection function to be tested, the frequency is increased 0.05 Hz in steps of at least 150% of the trip time delay stated in the protection function to be tested.

Test results are offered in the following tables:

Protective Function Tested	No Trip Test			Trip Test		
	Frequency value (Hz)	Time measured (s)	Trip	Frequency settling value (Hz)	Trip	Frequency trip value measured (Hz)
F< (Rep1)	47.20	> 1.5	<input checked="" type="checkbox"/> NO <input type="checkbox"/> YES	47.00	<input type="checkbox"/> NO <input checked="" type="checkbox"/> YES	47.00
F< (Rep2)	47.20	> 1.5	<input checked="" type="checkbox"/> NO <input type="checkbox"/> YES	47.00	<input type="checkbox"/> NO <input checked="" type="checkbox"/> YES	47.00
F< (Rep3)	47.20	> 1.5	<input checked="" type="checkbox"/> NO <input type="checkbox"/> YES	47.00	<input type="checkbox"/> NO <input checked="" type="checkbox"/> YES	47.00
F> (Rep1)	51.80	> 0.5	<input checked="" type="checkbox"/> NO <input type="checkbox"/> YES	52.00	<input type="checkbox"/> NO <input checked="" type="checkbox"/> YES	52.02
F> (Rep2)	51.80	> 0.5	<input checked="" type="checkbox"/> NO <input type="checkbox"/> YES	52.00	<input type="checkbox"/> NO <input checked="" type="checkbox"/> YES	52.02
F> (Rep3)	51.80	> 0.5	<input checked="" type="checkbox"/> NO <input type="checkbox"/> YES	52.00	<input type="checkbox"/> NO <input checked="" type="checkbox"/> YES	52.02

Maximum frequency deviation allowed is ± 0.10 Hz.

Test results are graphically shown in the following pages.

Underfrequency (F<) Rep 1

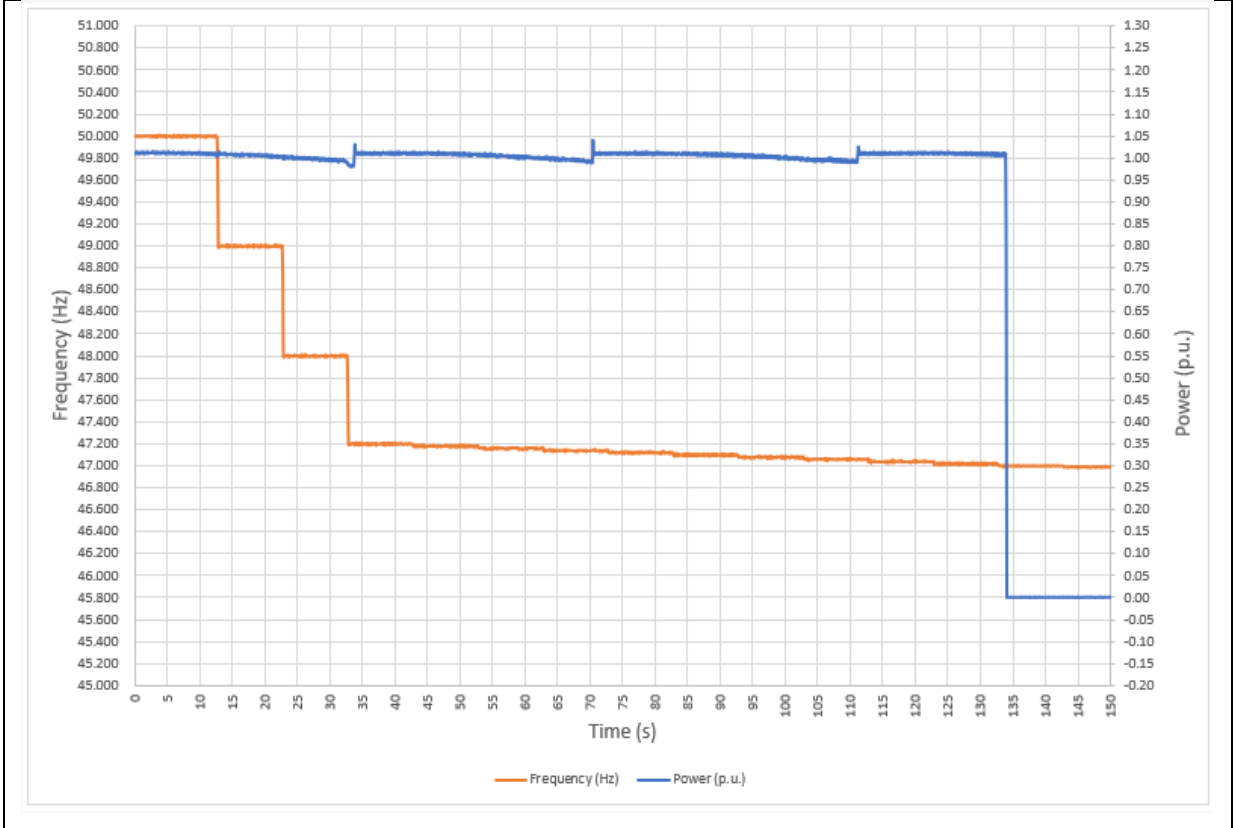

Underfrequency (F<) Rep 2

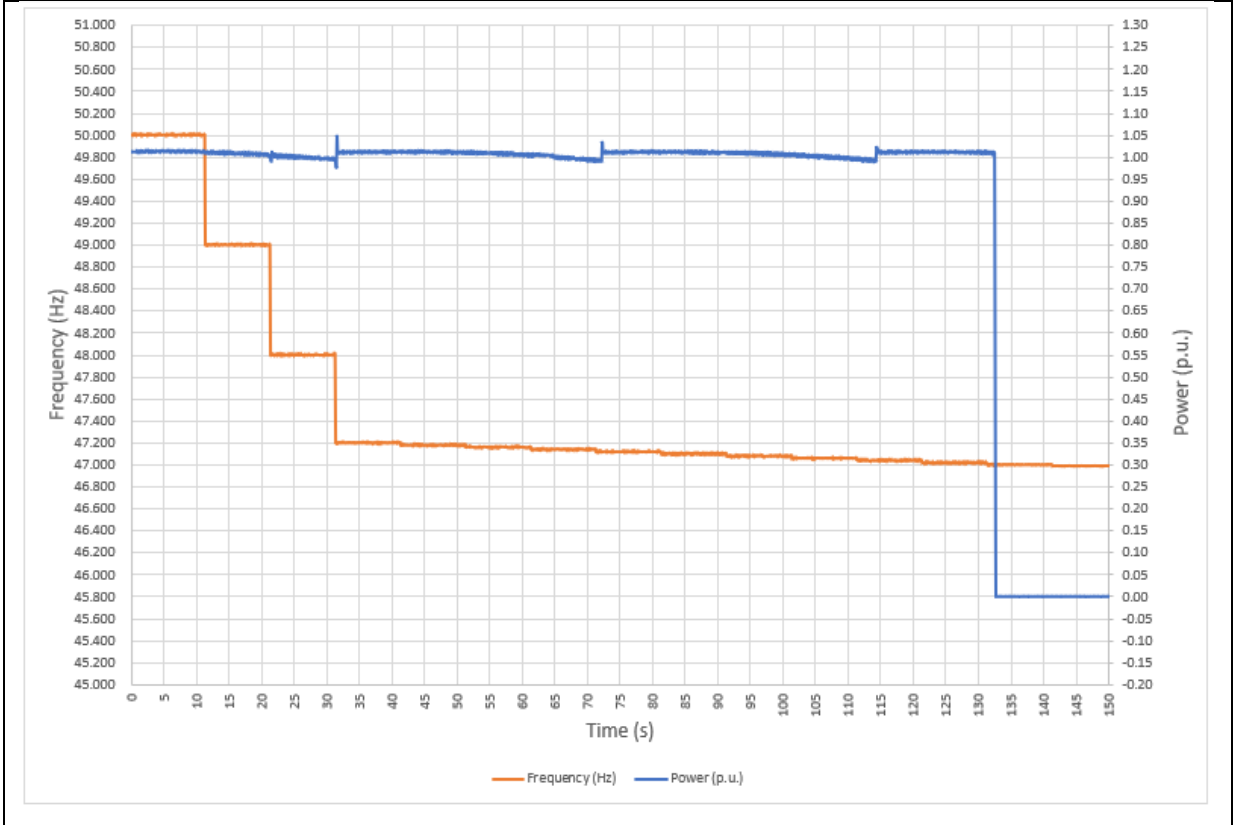

Underfrequency (F<) Rep 3

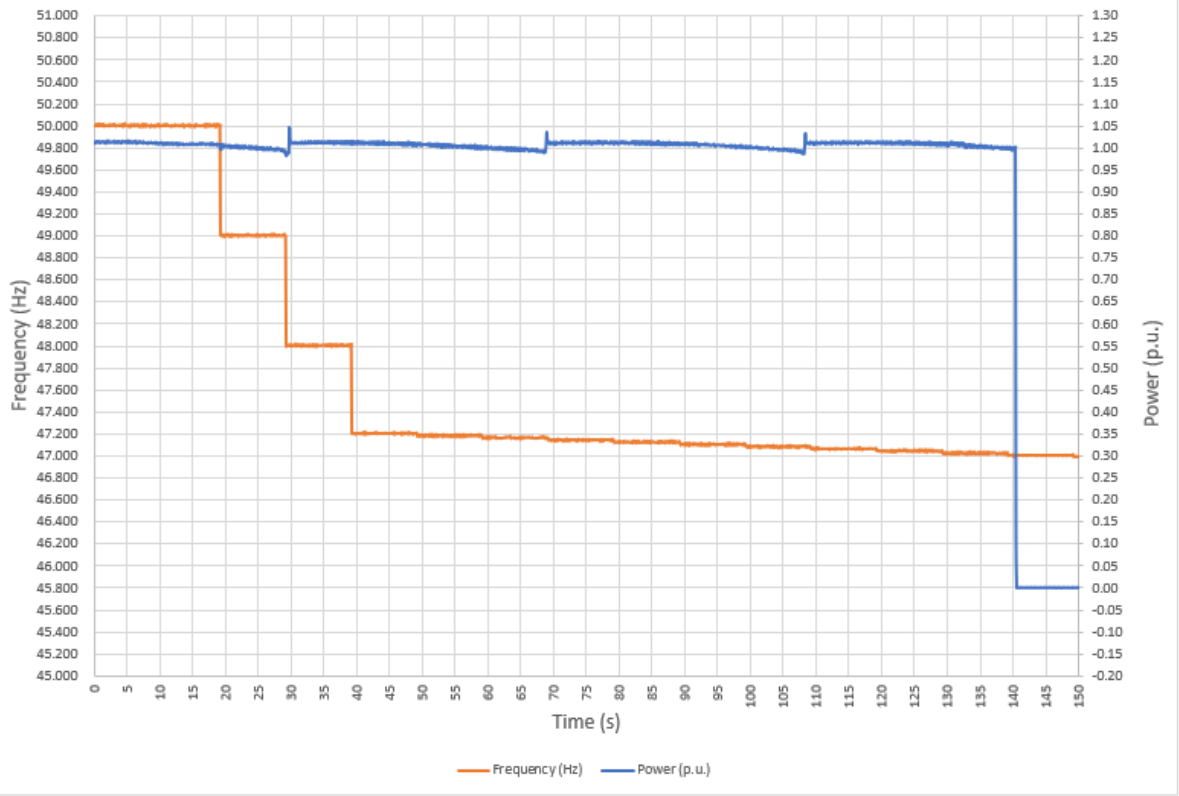

Overfrequency (F>) Rep 1

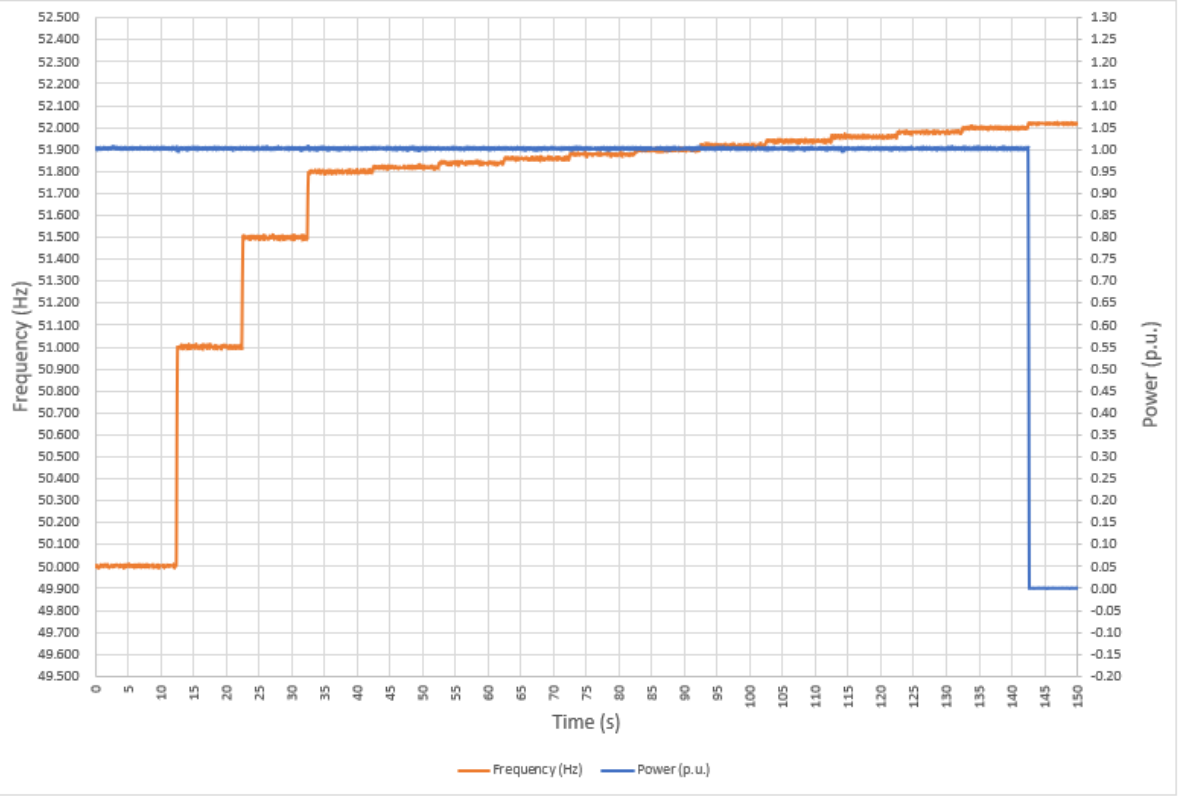

Overfrequency (F>) Rep 2

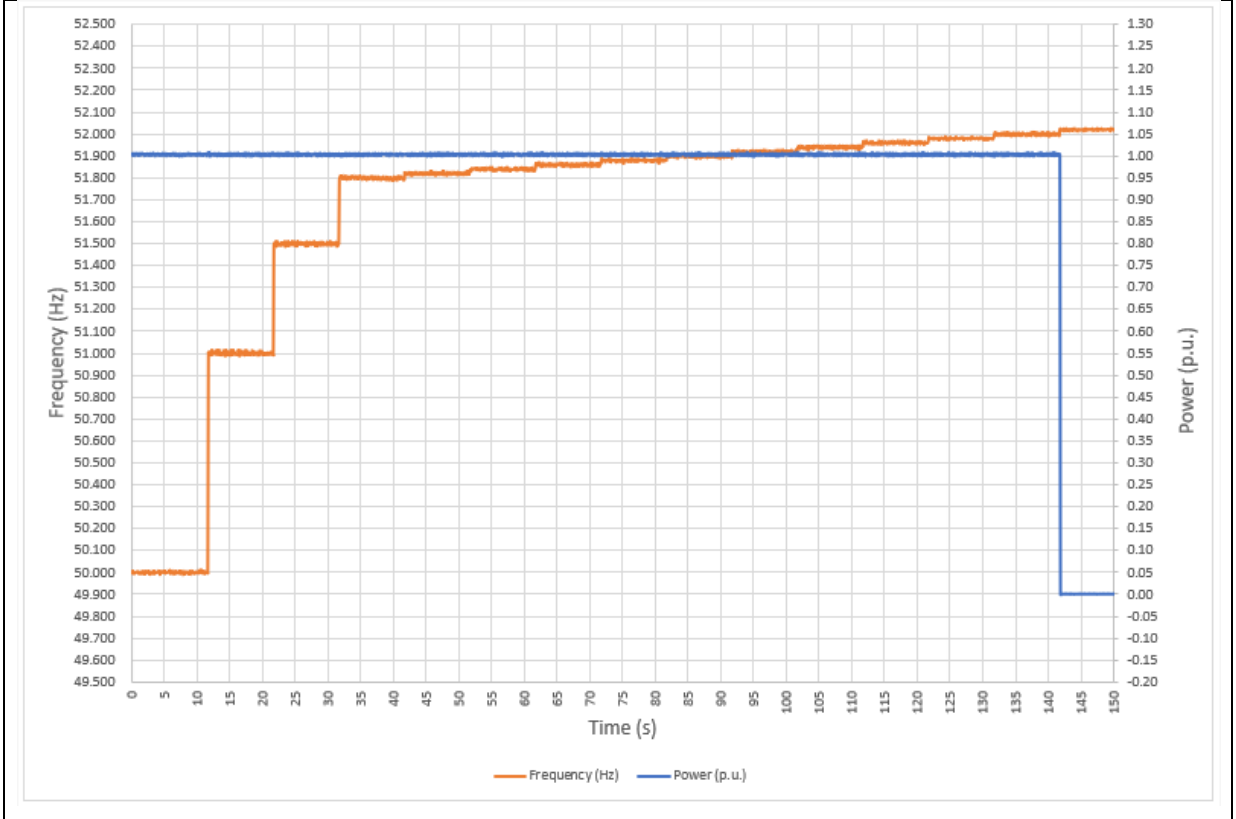

Overfrequency (F>) Rep 3

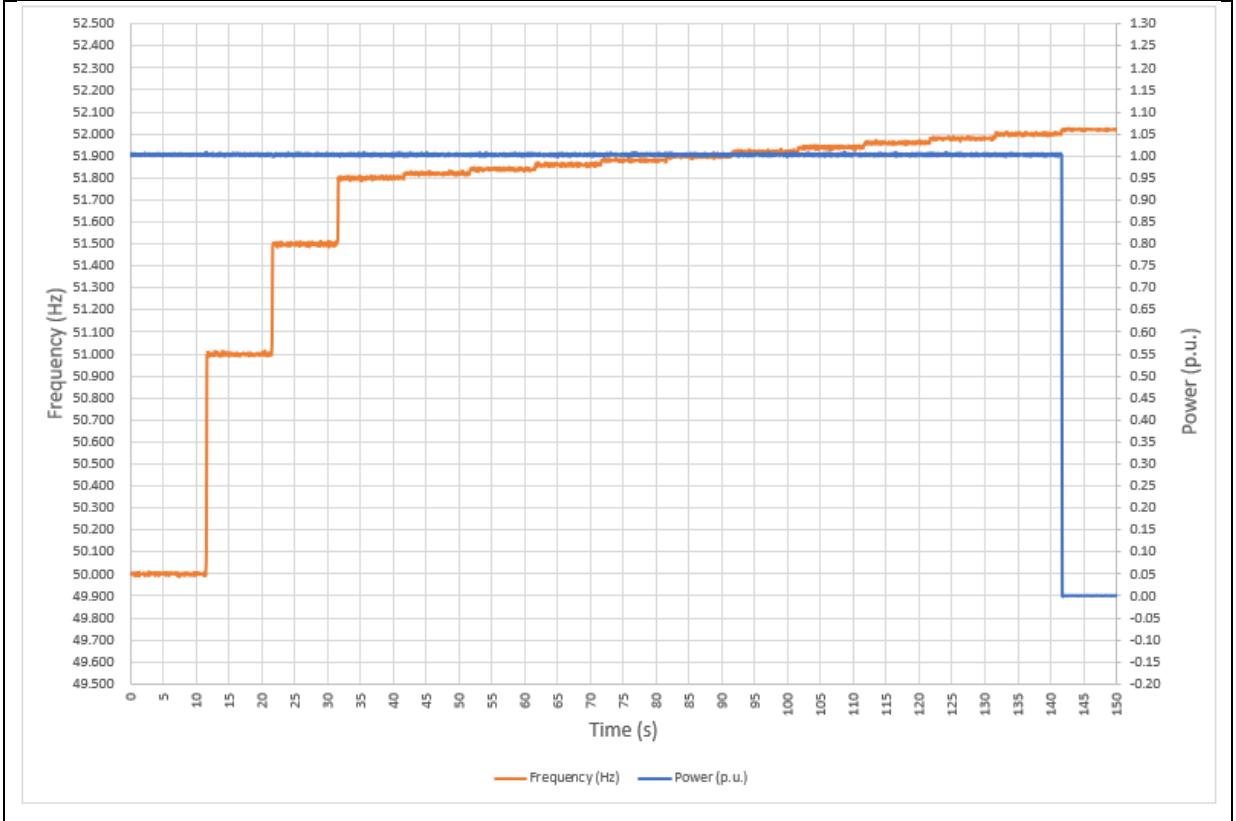

4.18.2.2 Frequency trip time tests

The tests have been made as the following procedure:

- For underfrequency protection: Maintaining the frequency with a value over the settling value during at least 1.5 seconds and then change the frequency to 46 Hz with a step.
- For overfrequency protection: Maintaining the frequency with a value below the settling value during at least 0.5 seconds and then change the frequency to 53 Hz with a step.

For underfrequency the standard states that the trip shall take place with a delay of at least 1 second and in less than 2 seconds, for overfrequency the condition stated by the standard is to trip in less than 0.2 seconds.

Test results are offered in the following tables:

Protective Function Tested	No Trip Test			Trip Test		
	Frequency value (Hz)	Time measured (s)	Trip	Frequency settling value (Hz)	Trip	Trip Time measured (ms)
F< (Rep 1)	47.10	> 1.5	<input checked="" type="checkbox"/> NO <input type="checkbox"/> YES	47.00	<input type="checkbox"/> NO <input checked="" type="checkbox"/> YES	1210
F< (Rep 2)	47.10	> 1.5	<input checked="" type="checkbox"/> NO <input type="checkbox"/> YES	47.00	<input type="checkbox"/> NO <input checked="" type="checkbox"/> YES	1214
F< (Rep 3)	47.10	> 1.5	<input checked="" type="checkbox"/> NO <input type="checkbox"/> YES	47.00	<input type="checkbox"/> NO <input checked="" type="checkbox"/> YES	1212
F> (Rep 1)	51.90	> 0.5	<input checked="" type="checkbox"/> NO <input type="checkbox"/> YES	52.00	<input type="checkbox"/> NO <input checked="" type="checkbox"/> YES	112
F> (Rep 2)	51.90	> 0.5	<input checked="" type="checkbox"/> NO <input type="checkbox"/> YES	52.00	<input type="checkbox"/> NO <input checked="" type="checkbox"/> YES	106
F> (Rep 3)	51.90	> 0.5	<input checked="" type="checkbox"/> NO <input type="checkbox"/> YES	52.00	<input type="checkbox"/> NO <input checked="" type="checkbox"/> YES	104

Maximum frequency deviation allowed is ± 0.10 Hz.

Test results are graphically shown in the following pages.

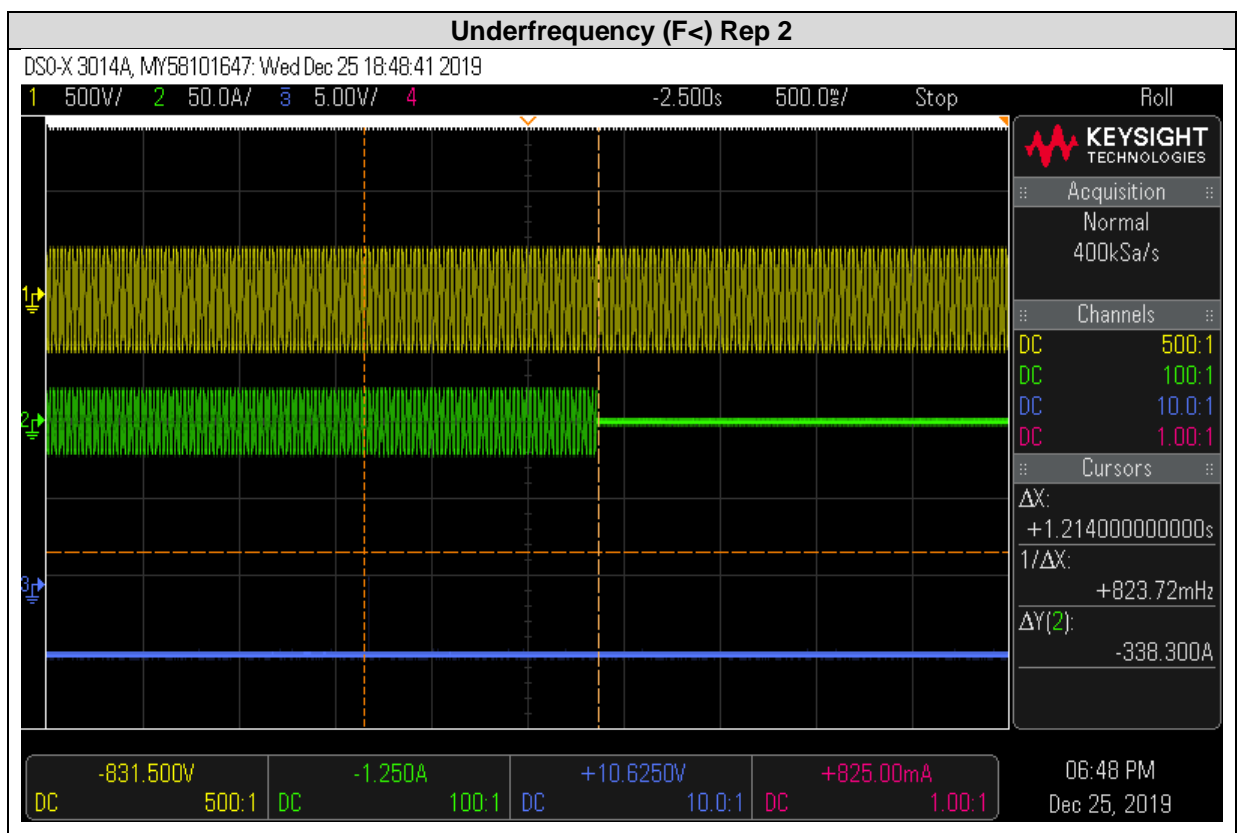
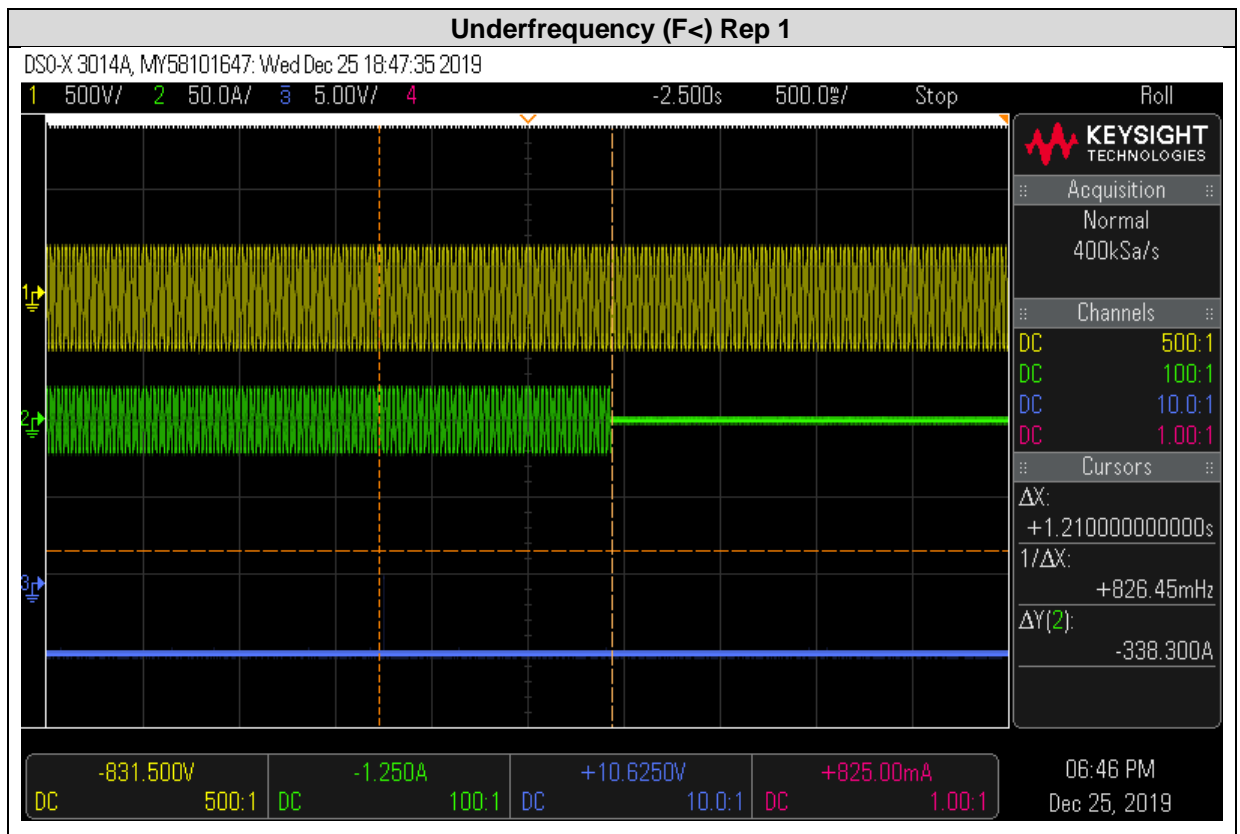

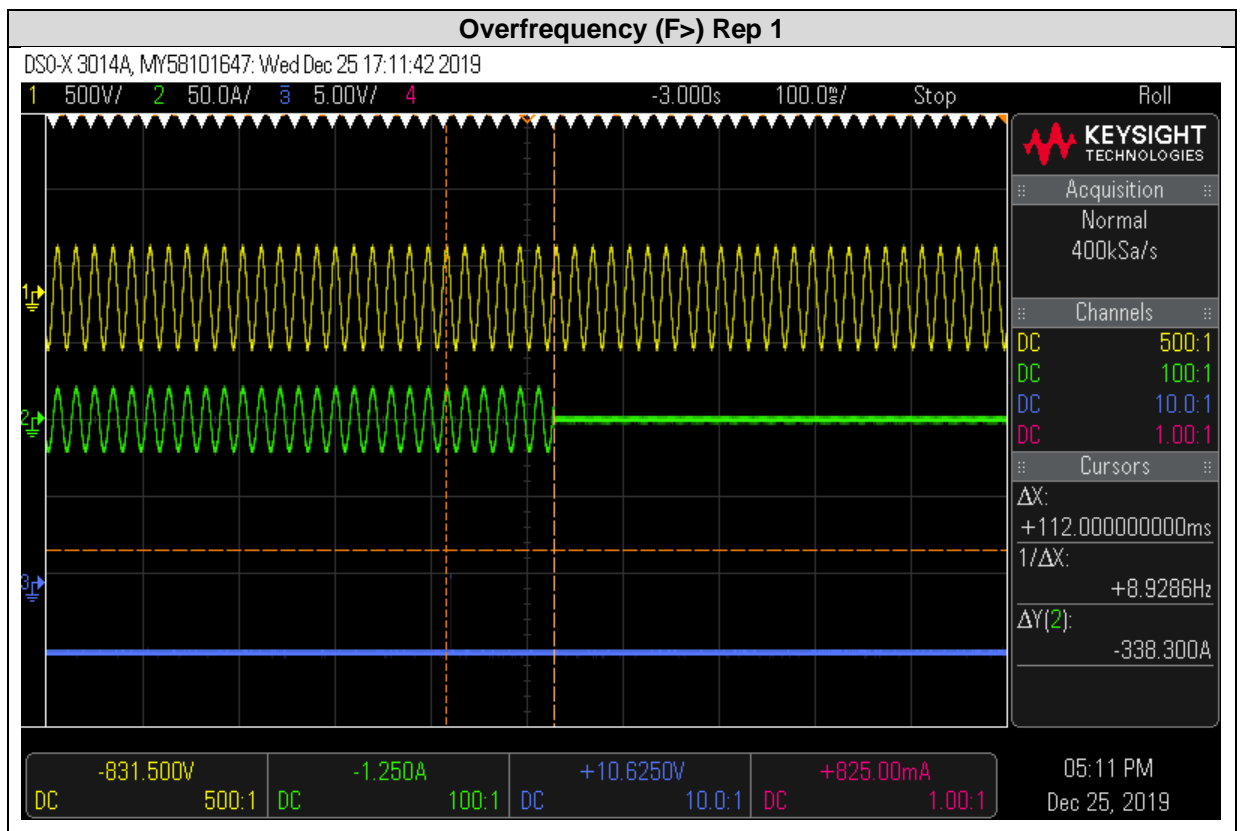
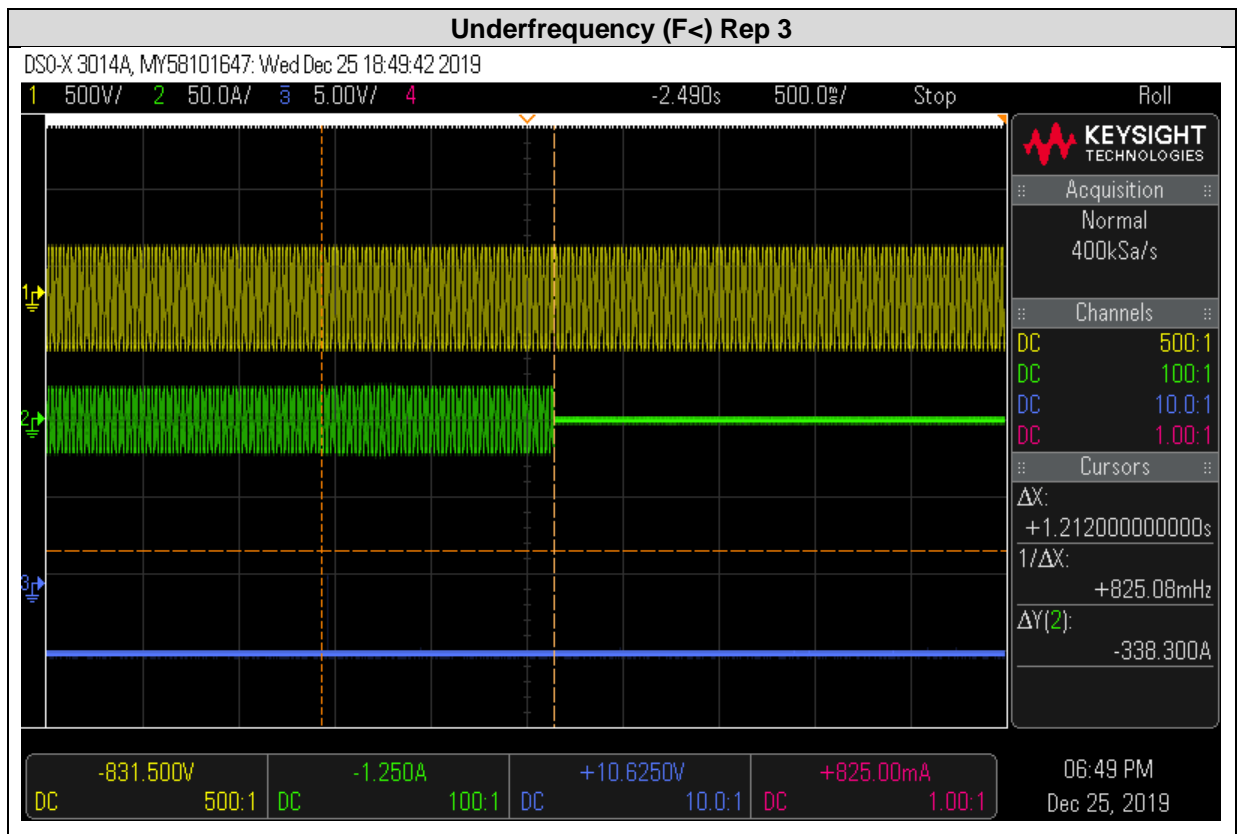

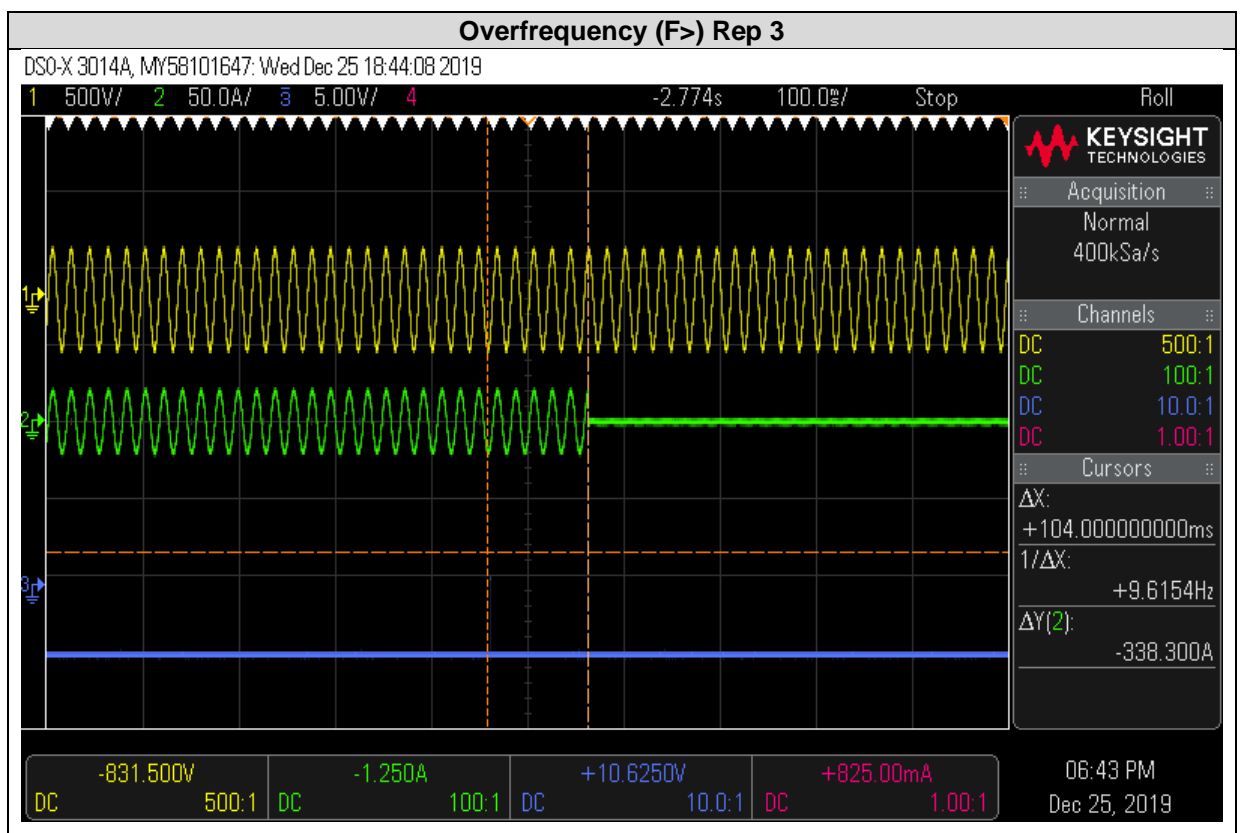
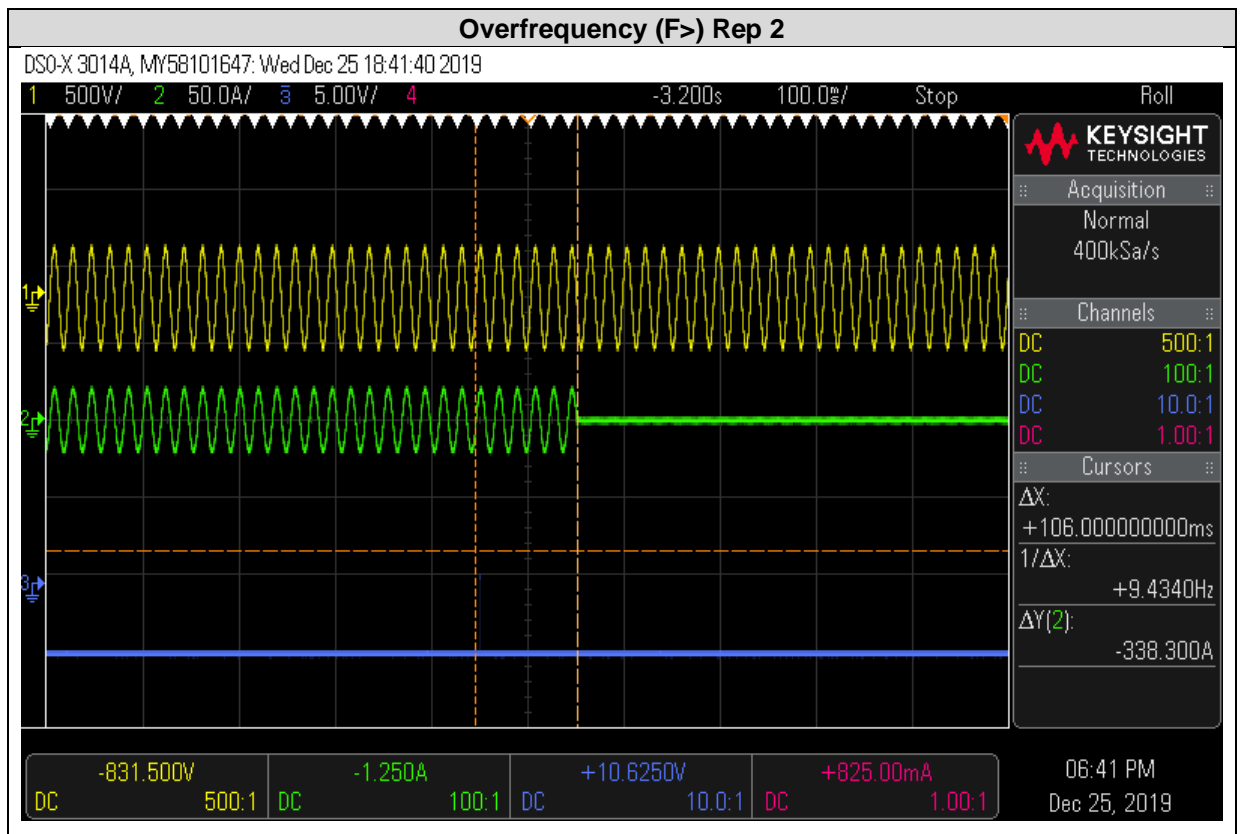

4.19 SUSTAINED OPERATION FOR VOLTAGE VARIATIONS

Tests for verifying the limits sustained operation for voltage variations have been carried out according to the Clause 7.5.2 of the standard.

The inverter shall operate the automatic disconnection device within 3 seconds when the average voltage for a 10 min period exceeds the V_{nom_max} . The voltage value applied for V_{nom_max} is 255 V for Australia and 246 V for New Zealand.

For the test performed, it has been verified that the inverter trips when any of the calculated voltage averages for total of the single-phase system is above V_{nom_max} .

The test has been repeated 3 times for verifying the accuracy of the voltage trip value and 1 additional time to verify the trip time.

The admissible tolerance between setting value and trip value of the voltage is at maximum $\pm 1\%$.

4.19.1 Voltage trip value tests

Starting from a voltage level equal to U_n , this voltage is maintained a considerable time verifying that voltage averages calculated in each line are close to U_n .

Then, the output voltage is increased up to a voltage equal to the V_{nom_max} setting less 1 V. This level is maintained for 5 minutes.

After this, the output voltage is increased up to a voltage equal to the V_{nom_max} setting plus 1 V. This level is maintained up to the inverter trips and the voltage average value is recorded.

The table below offers test results obtained. Where the test procedure above mentioned has been applied.

Test number	Threshold Value (V)	No Trip Test			Trip Test		
		Voltage value (V)	Time measured (s)	Trip	Voltage settling value (V)	Trip	Trip voltage average value (V)
Setting according to AS 60038 for Australia							
1	255.0	254.0	> 300	<input checked="" type="checkbox"/> NO <input type="checkbox"/> YES	256.0	<input type="checkbox"/> NO <input checked="" type="checkbox"/> YES	254.9
2	255.0	254.0	> 300	<input checked="" type="checkbox"/> NO <input type="checkbox"/> YES	256.0	<input type="checkbox"/> NO <input checked="" type="checkbox"/> YES	254.9
3	255.0	254.0	> 300	<input checked="" type="checkbox"/> NO <input type="checkbox"/> YES	256.0	<input type="checkbox"/> NO <input checked="" type="checkbox"/> YES	255.1
Setting according to IEC 60038 for New Zealand							
1	246.0	245.0	> 300	<input checked="" type="checkbox"/> NO <input type="checkbox"/> YES	247.0	<input type="checkbox"/> NO <input checked="" type="checkbox"/> YES	246.1
2	246.0	245.0	> 300	<input checked="" type="checkbox"/> NO <input type="checkbox"/> YES	247.0	<input type="checkbox"/> NO <input checked="" type="checkbox"/> YES	246.2
3	246.0	245.0	> 300	<input checked="" type="checkbox"/> NO <input type="checkbox"/> YES	247.0	<input type="checkbox"/> NO <input checked="" type="checkbox"/> YES	246.3

After these test results, it is considered the most restrictive trip voltage average value for verifying the trip time. With this,

The V_{nom_max} is set to 255 V in the following test:

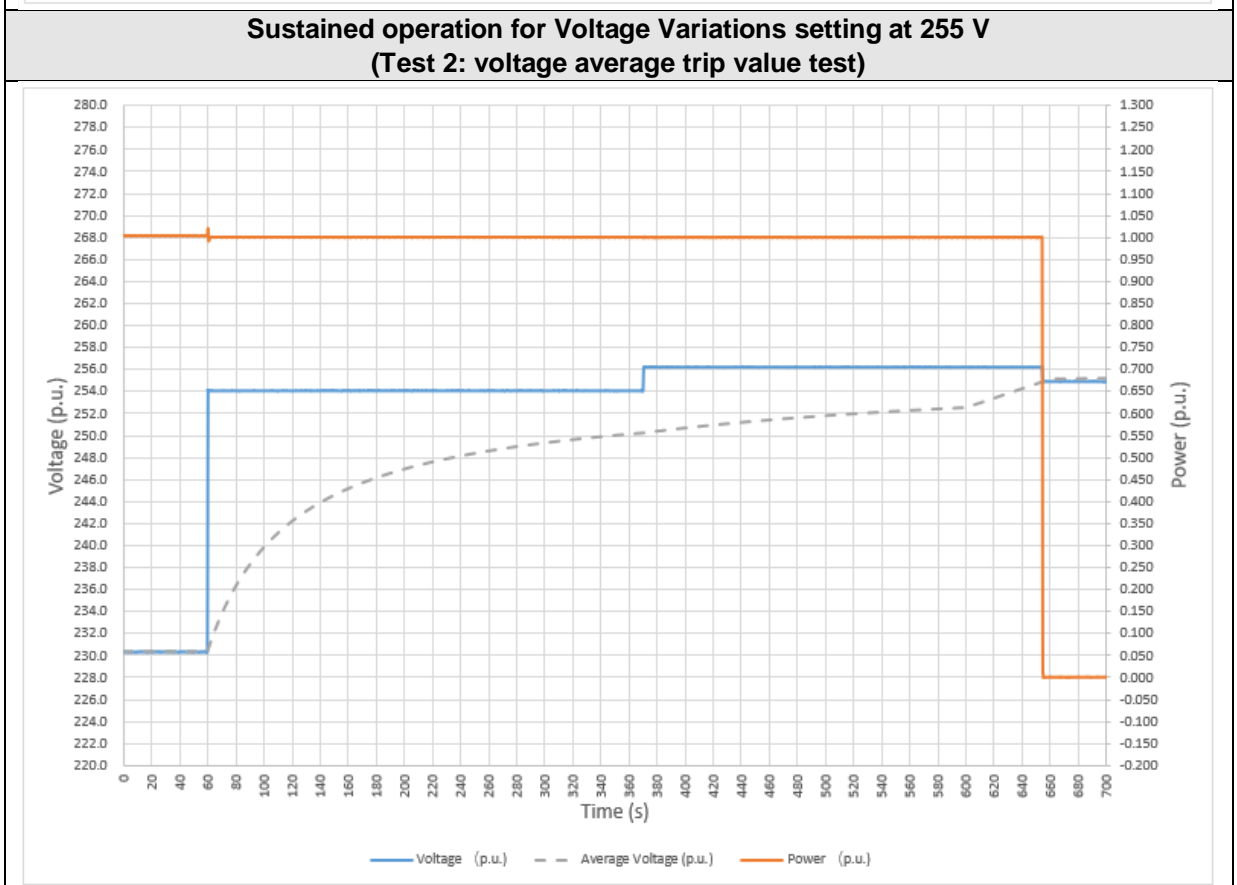
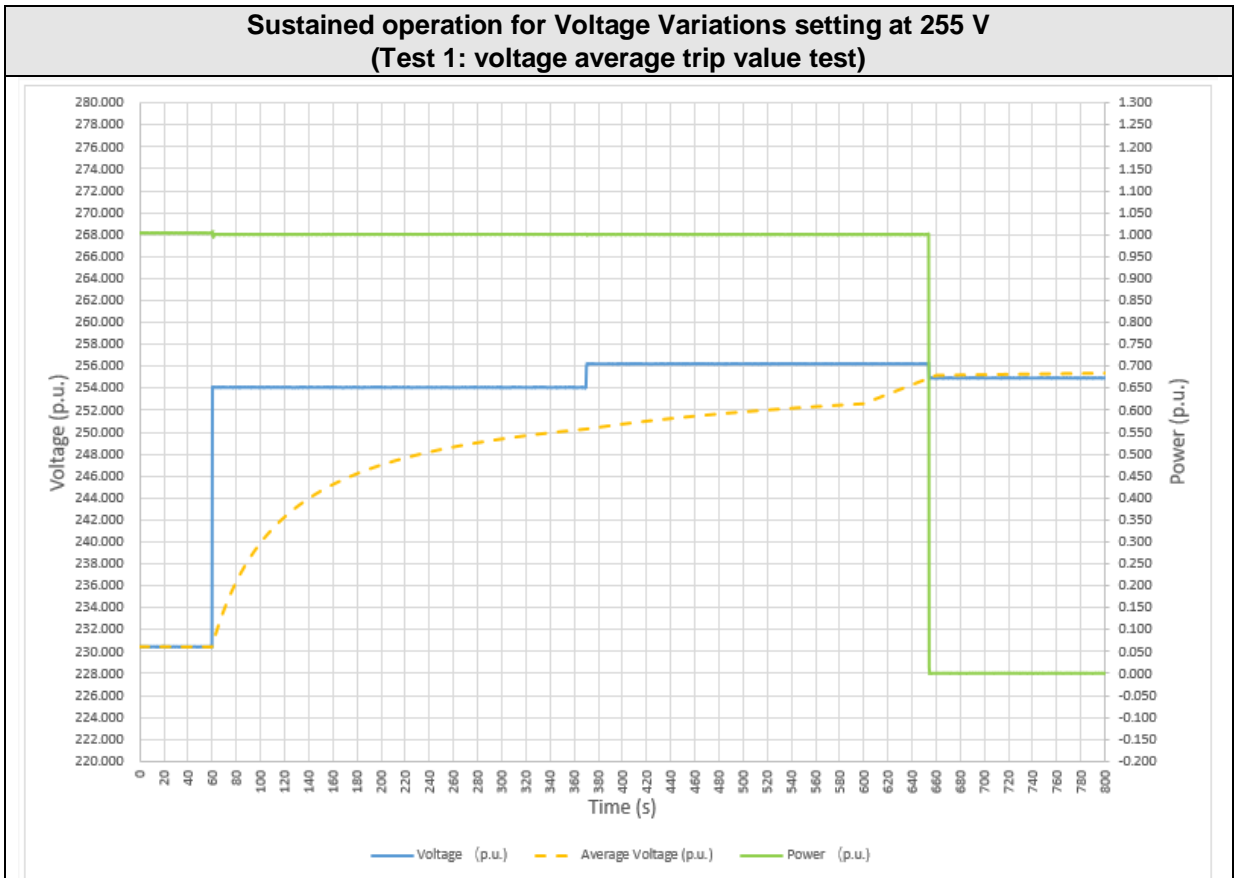

**Sustained operation for Voltage Variations setting at 255 V
(Test 3: voltage average trip value test)**

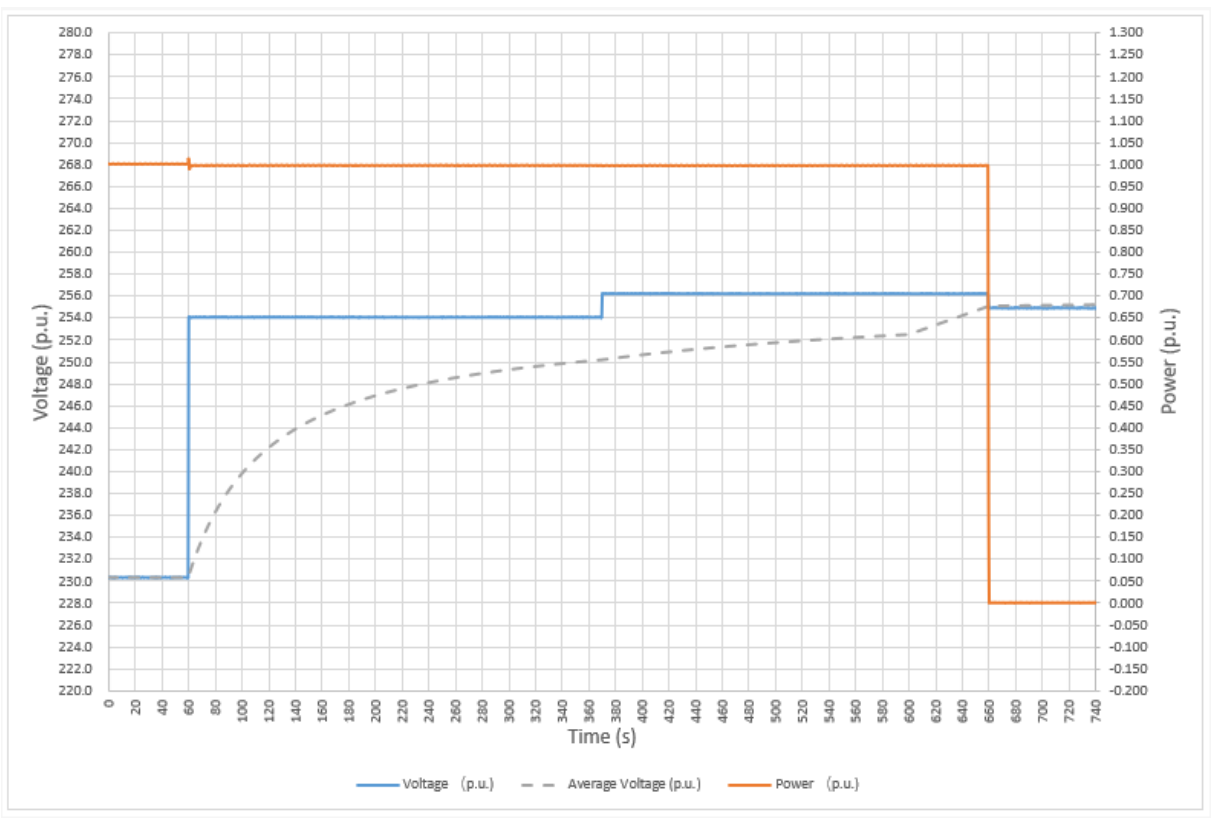

The V_{nom_max} is set to 246 V in the following test:

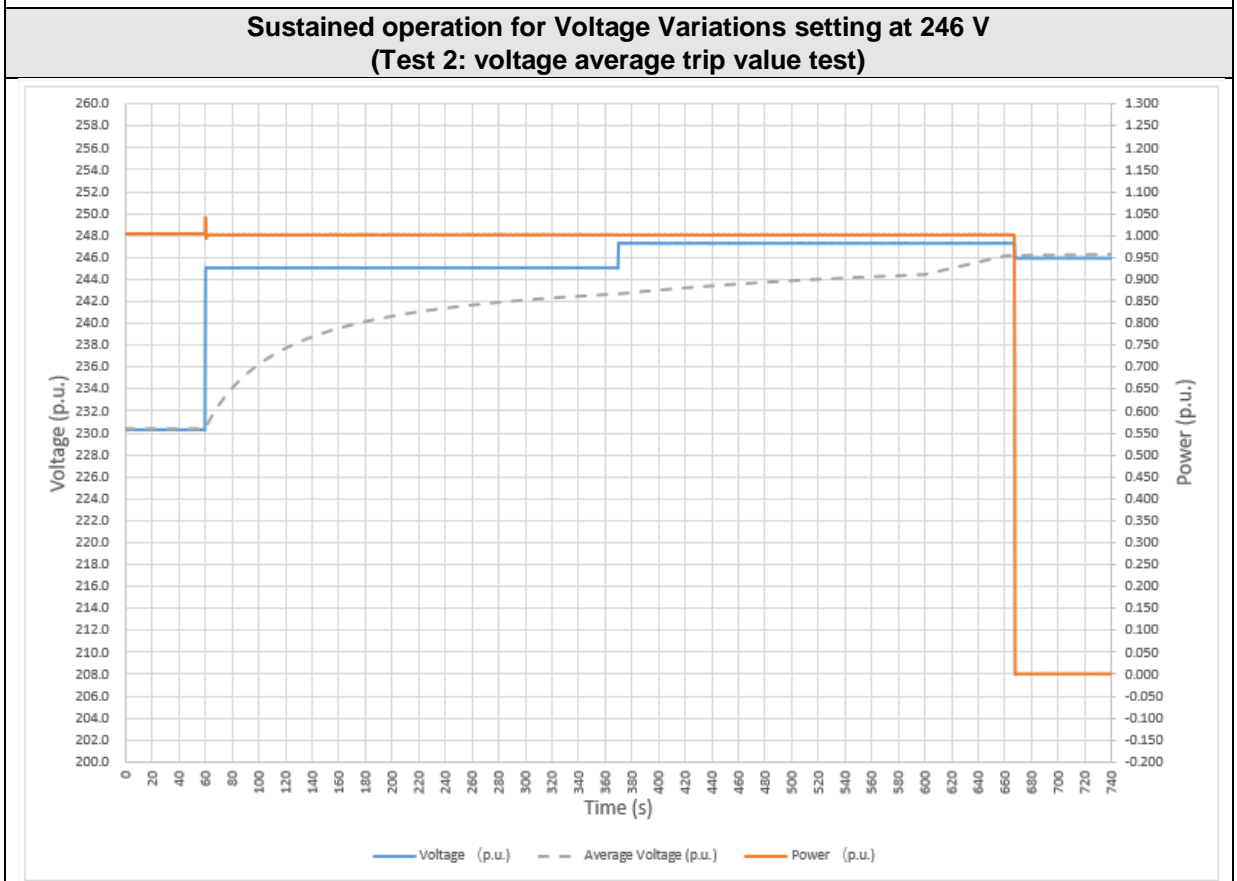
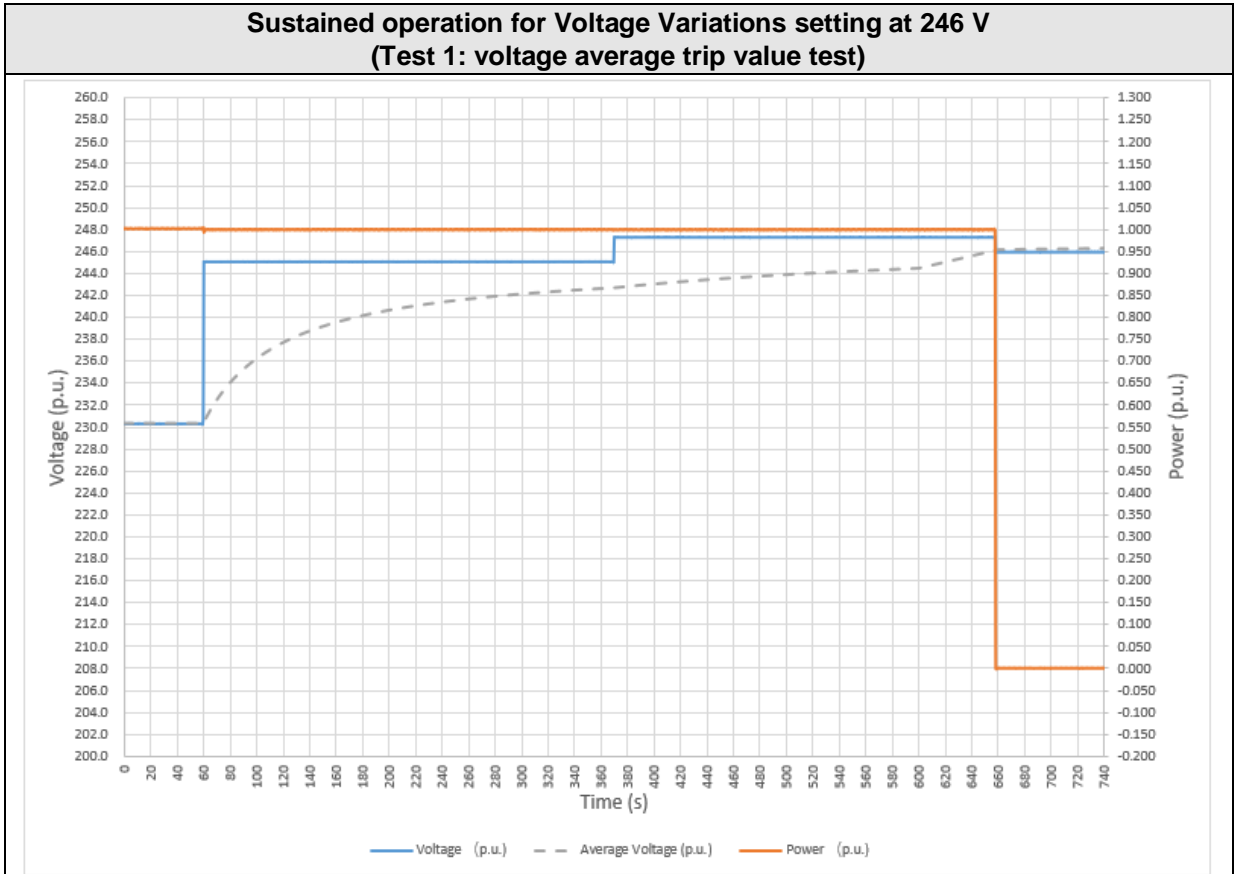

**Sustained operation for Voltage Variations setting at 246 V
(Test 3: voltage average trip value test)**

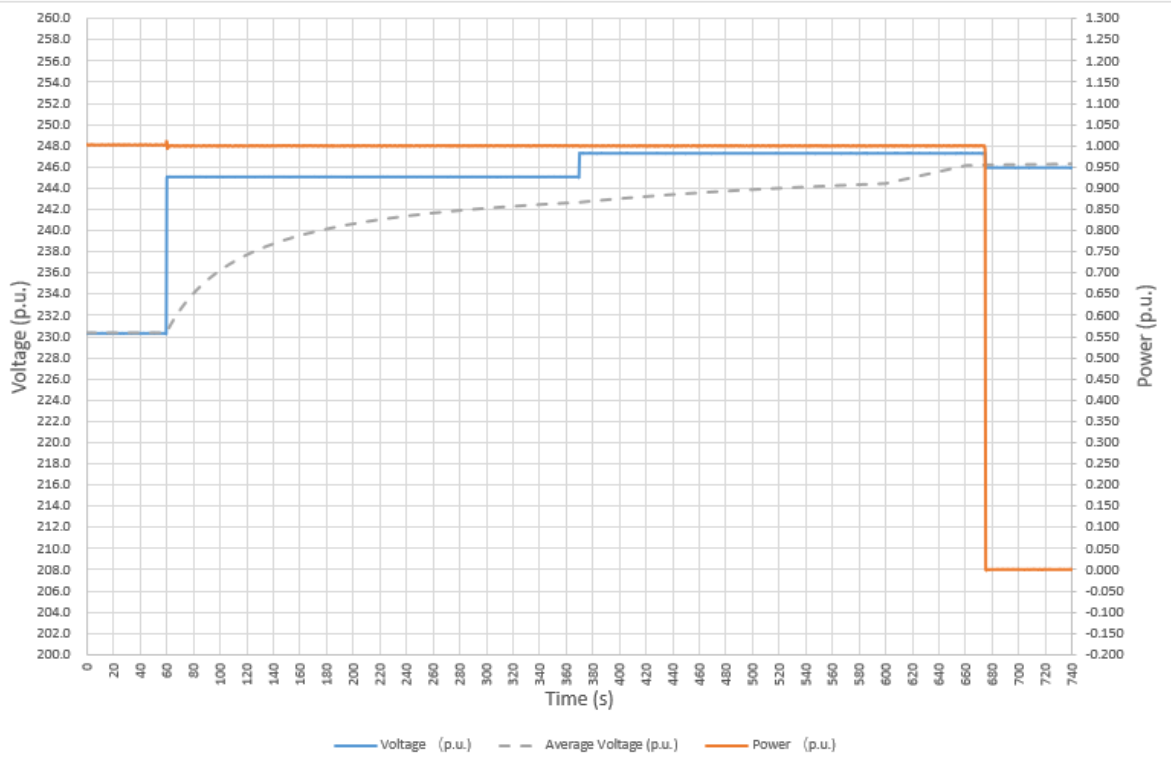

4.19.2 Trip time test

Starting from a voltage level equal to U_n , this voltage is maintained a considerable time verifying that voltage averages calculated in each line are close to U_n .

Then, the output voltage is increased up to a voltage equal to the V_{nom_max} setting calculated after the test 1. This level is maintained for 10 minutes.

After this, the output voltage is increased up to a voltage equal to the V_{nom_max} setting plus 2 V. This level is maintained up to the inverter trips and the voltage average value is recorded. This trip time shall be less than 30 seconds.

The table below offers test results obtained, where the test procedure above mentioned has been applied.

Threshold Value (V)	No Trip Test			Trip Test		
	Voltage value (V)	Time measured (s)	Trip	Voltage value (% U_n)	Trip	Measured Trip time (s)
Setting according to AS 60038 for Australia						
255	255.1	> 600	<input checked="" type="checkbox"/> NO <input type="checkbox"/> YES	257.2	<input type="checkbox"/> NO <input checked="" type="checkbox"/> YES	20.1
Setting according to IEC 60038 for New Zealand						
246	245.4	> 600	<input checked="" type="checkbox"/> NO <input type="checkbox"/> YES	247.2	<input type="checkbox"/> NO <input checked="" type="checkbox"/> YES	19.2

Sustained operation for Voltage Variations setting at 255 V (trip time test)

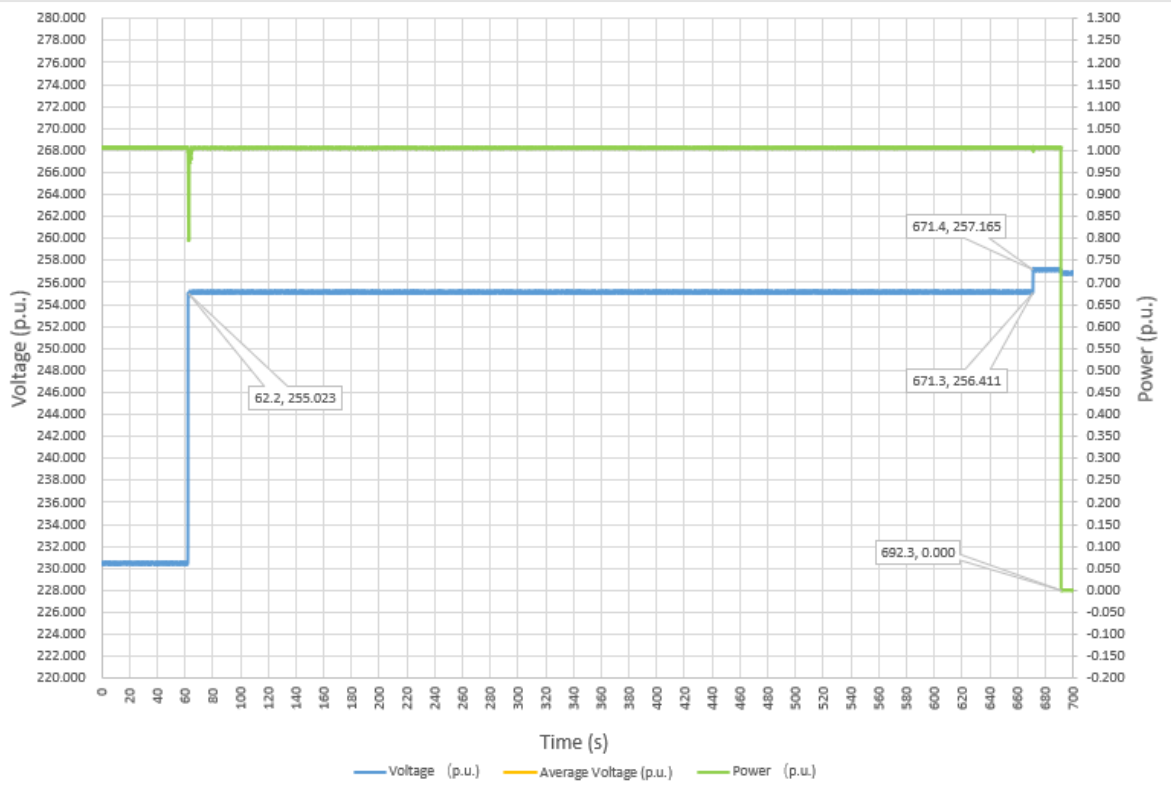

Sustained operation for Voltage Variations setting at 246 V (trip time test)

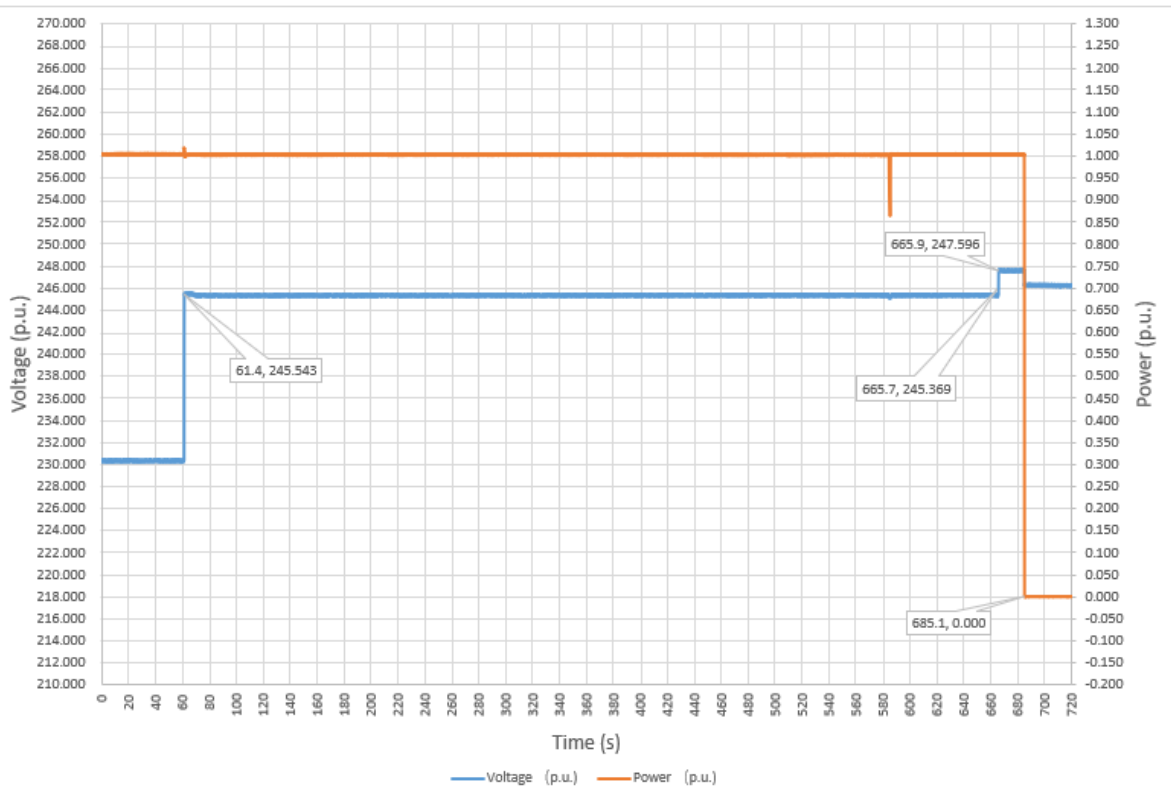

4.20 SUSTAINED OPERATION FOR FREQUENCY VARIATIONS

Sustained operation for frequency variations has been measured according to the Clause 7.5.3 of the standard.

4.20.1 Response to an increase in frequency

According to the clause 7.5.3.1 the inverter must be able to comply with the following requirements:

- Test 1: Linear decrease of the active power up to disconnection in front of over frequency variations up to 52 Hz.
- Test 2: Hysteresis capability once over frequency variations are recovered up to 50.15 Hz.

When the inverter's frequency returns to operate with $f < 50.15$ Hz, the active power must be recovered in both cases according to a power ramp limit and with a delay of at least 60 seconds.

Test results obtained are shown in the following tables and graphs.

Test 1. Over frequency variations up to disconnection and active power recovery				
%P _n	Frequency (Hz)	Power measured (W)	Power desired (W)	ΔP (%P _M)
50%	50.00	1653	1650	0.20
	50.10	1653	1650	0.18
	50.20	1653	1650	0.16
	50.30	1613	1603	0.61
	50.40	1519	1509	0.61
	50.50	1424	1414	0.61
	50.60	1330	1320	0.61
	50.70	1236	1226	0.60
	50.80	1141	1131	0.59
	50.90	1047	1037	0.59
	51.00	953	943	0.60
	51.10	859	849	0.64
	51.20	765	754	0.63
	51.30	670	660	0.63
	51.40	576	566	0.63
	51.50	482	471	0.64
	51.60	388	377	0.65
	51.70	294	283	0.66
	51.80	199	189	0.63
	51.90	103	94	0.51
	52.00	7	0	0.45
	52.10	4	0	0.23
	52.20	4	0	0.23
	52.00	3	0	0.21
	51.80	4	0	0.22
	51.60	4	0	0.22
	51.40	4	0	0.22
	51.20	4	0	0.22
	51.00	4	0	0.22
	50.80	4	0	0.22
50.60	4	0	0.23	
50.40	4	0	0.23	
50.20	4	0	0.23	

There is allowed a maximum tolerance for active power measurements up to $\pm 5\%$ of the starting power (P_M).

Test 1
PvsF behaviour

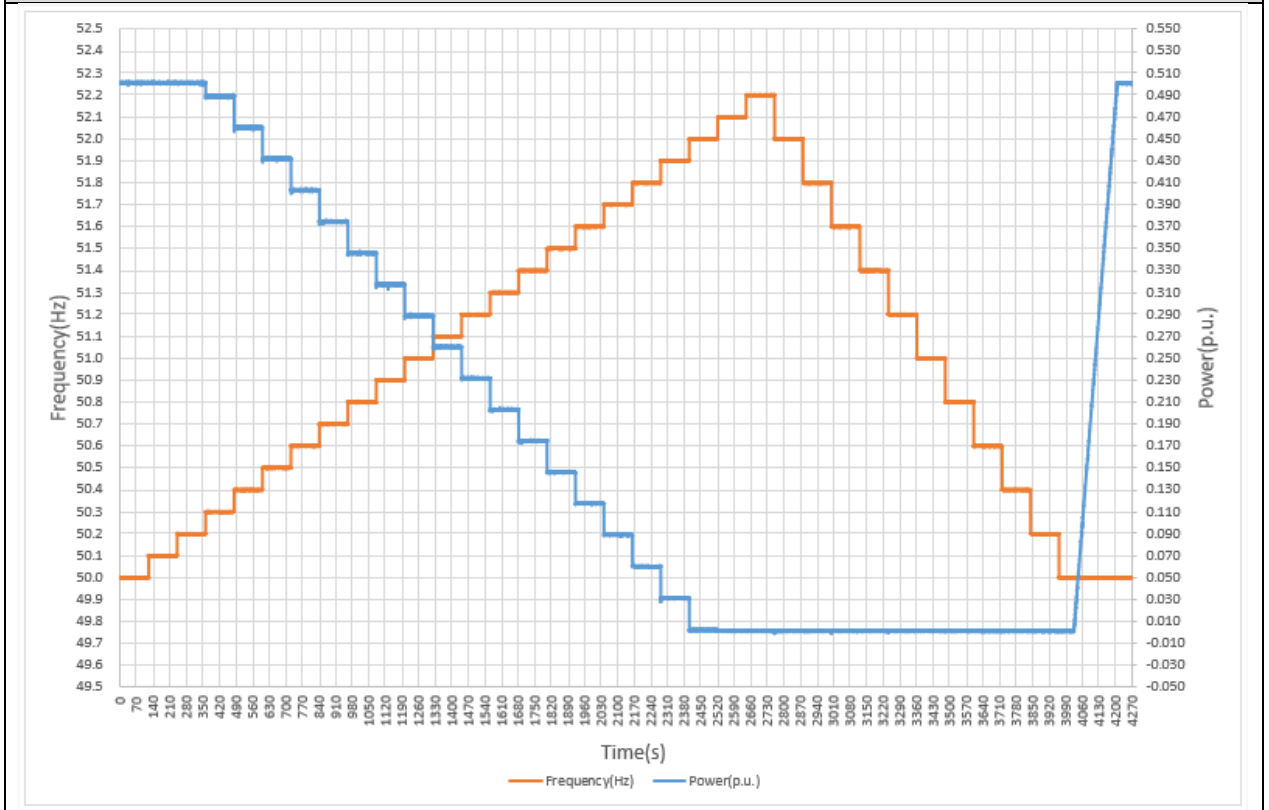

Reconnection Power gradient

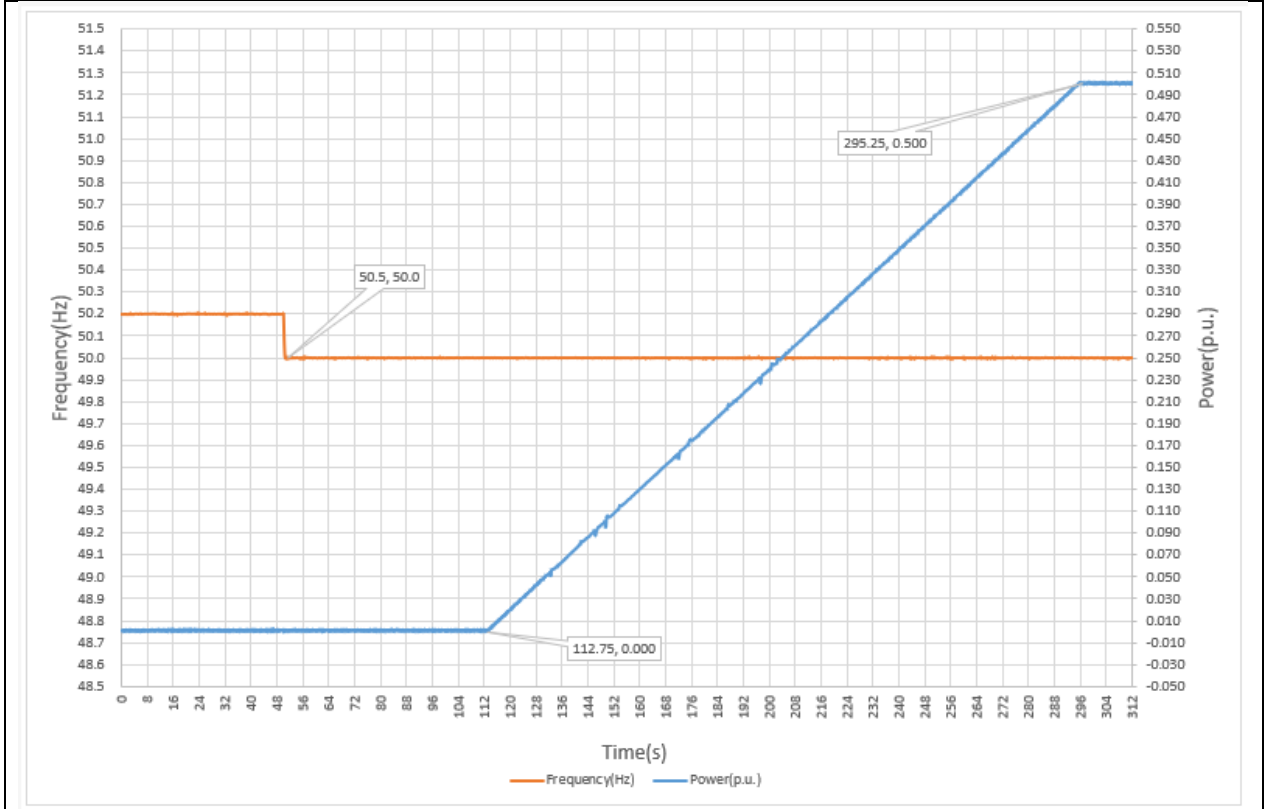

Reconnection Value: 50.00 Hz
Increase of active power desired: 16.7 %Pn/min

Reconnection time: 62.25 s
Increase measured: 16.4 %Pn/min

Output power reduction

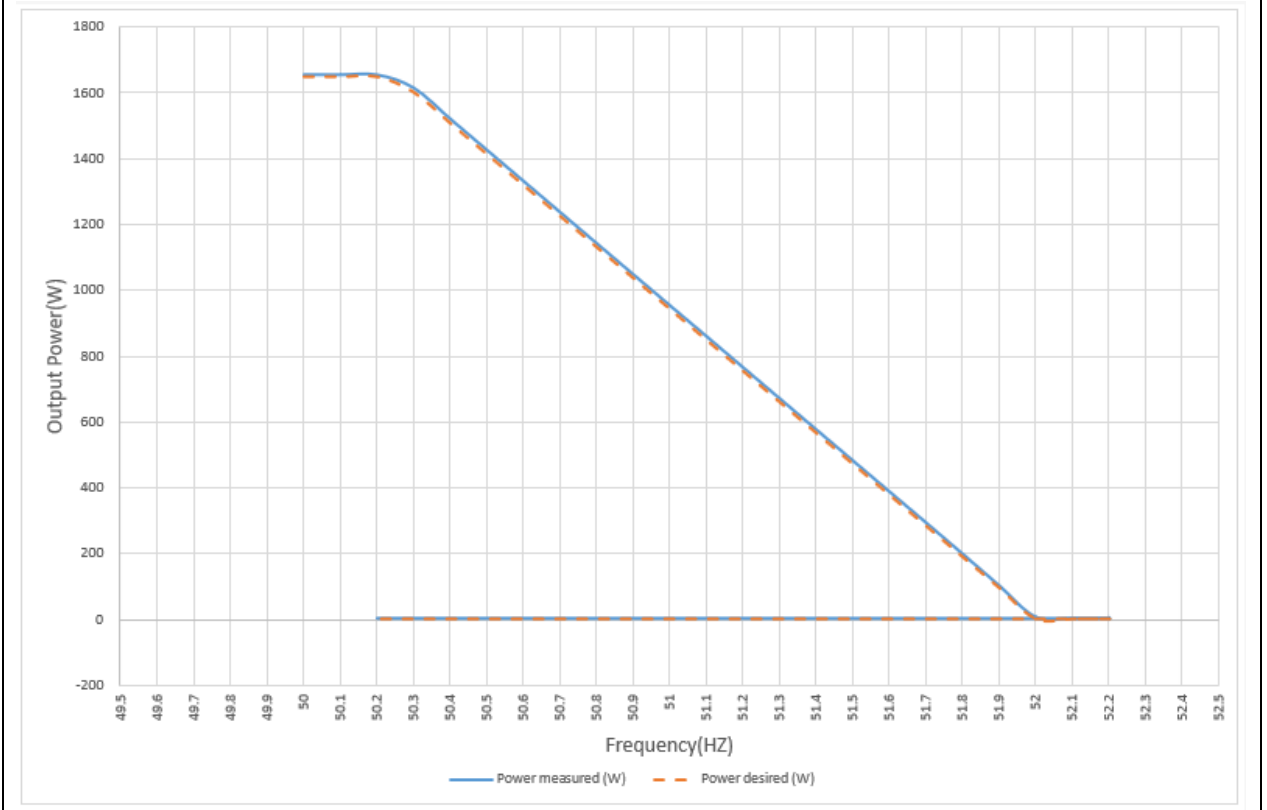

Test 2. Hysteresis capability and active power recovery				
%P_n	Frequency	Power measured (W)	Power desired (W)	ΔP (%P_M)
50%	50.00	1652	1650	0.12
	50.10	1652	1650	0.11
	50.20	1652	1650	0.11
	50.30	1605	1603	0.13
	50.40	1511	1509	0.16
	50.50	1417	1414	0.19
	50.60	1323	1320	0.21
	50.70	1230	1226	0.23
	50.80	1135	1131	0.24
	50.90	1042	1037	0.27
	51.00	948	943	0.32
	50.80	948	943	0.31
	50.60	948	943	0.31
	50.40	948	943	0.30
	50.20	948	943	0.31

There is allowed a maximum tolerance for active power measurements up to $\pm 5\%$ of the starting power (P_M).

Test results are graphically shown in the following pages.

Test 2
PvsF behaviour

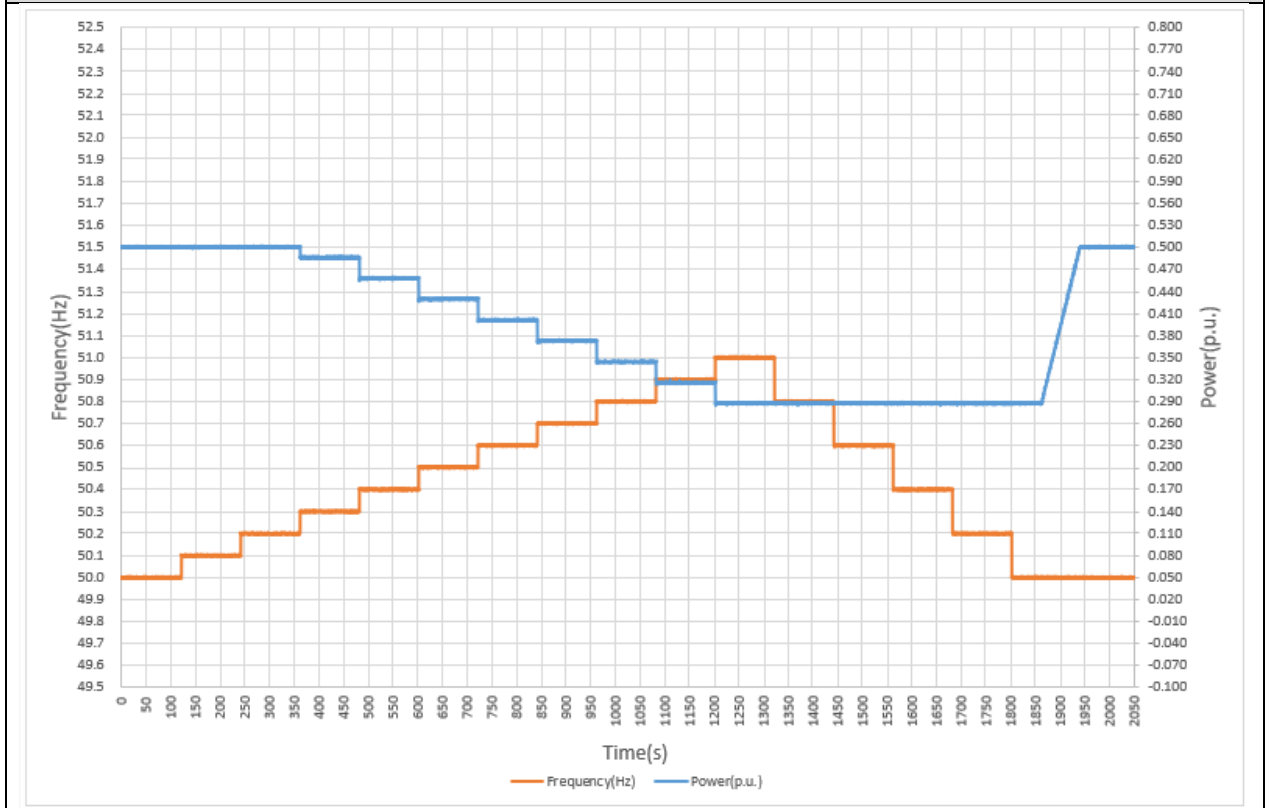

Power Recovery Gradient

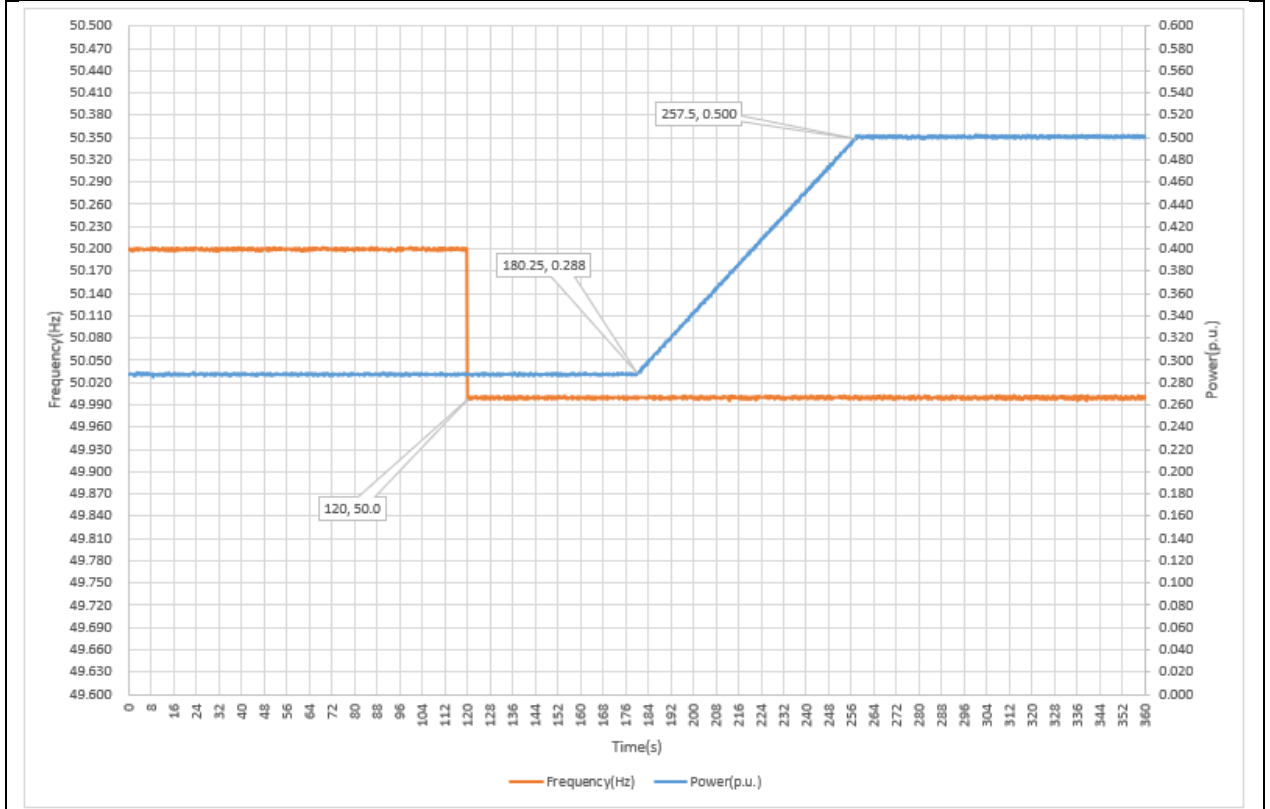

Recovery Value: 50.00 Hz

Power recovery time: 60.25 s

Increase of active power desired: 16.7 %Pn/min

Increase measured: 16.4 %Pn/min

Output power reduction

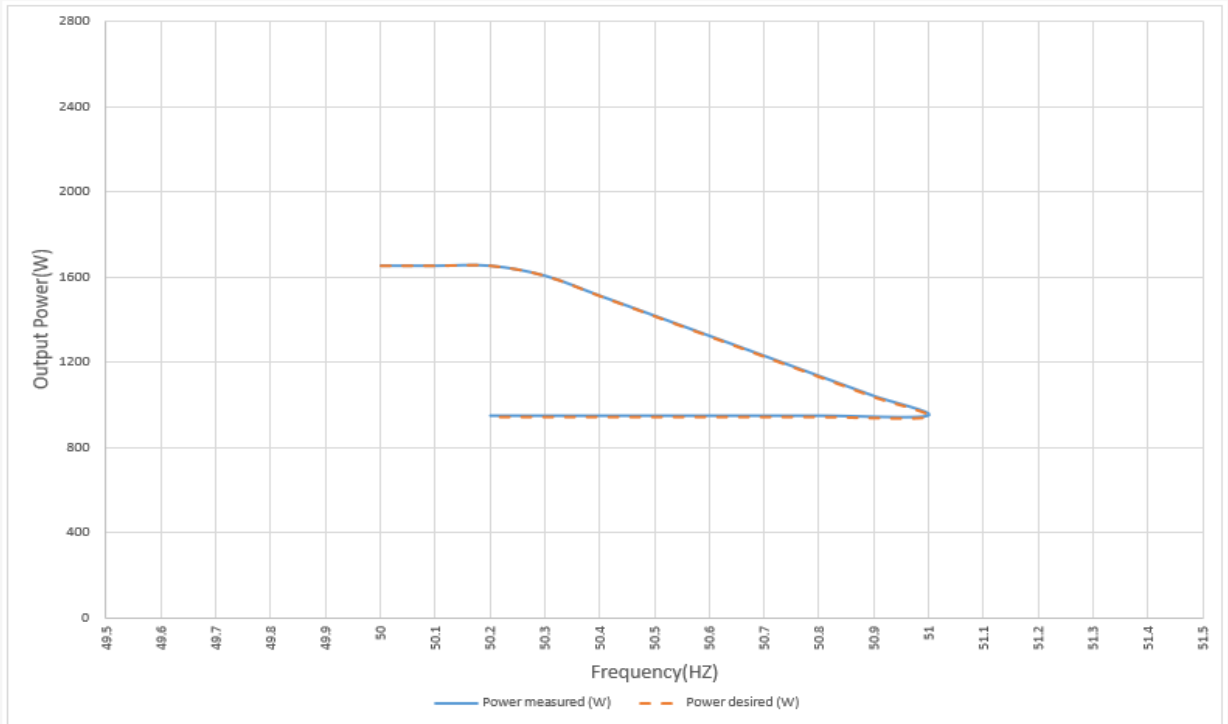

4.20.2 Response to a decrease in grid frequency

According to the clause 7.5.3.2, the inverter must be capable of supplying rated power between 49 Hz and 49.75 Hz for Australia.

- Test 1: Linear decrease of the active power up to disconnection in front of under frequency variations up to 49.0 Hz.
- Test 2: Hysteresis capability once over frequency variations are recovered up 49.5Hz.

When the inverter's frequency returns to operate with $f > 49.85$ Hz, the active power must be recovered in both cases according to a power ramp limit and with a delay of at least 60 seconds.

Test is waived due to the inverter is not energy storage.

4.21 DISCONNECTION ON EXTERNAL SIGNAL

The automatic disconnection device shall incorporate the ability to disconnect on an external signal. If an external signal or demand response 'DRM 0' condition is asserted, the automatic disconnection device shall operate within 2 s.

Refer to point 4.12.1 for details.

4.22 CONNECTION AND RECONNECTION PROCEDURE

According to the clause 7.7 of the standard, voltage and frequency conditions for allowing the connection or reconnection of the equipment to the grid are as follows:

- The voltage of the grid has to be maintained within the limits of AS 60038, for Australia, for at least 60 s.
- The frequency of the grid has to be maintained within the range 47.5 Hz to 50.15 Hz for at least 60 s.

4.22.1 Frequency Connection

Test results are offered in the following tables:

Frequency Connection Value Limit	No Connection Test			Connection Test		
	Frequency value (Hz)	Time measured (s)	Connection	Frequency value (Hz)	Connection	Time measured (s)
$F \geq 47.50$ Hz	47.45	>120	<input checked="" type="checkbox"/> NO <input type="checkbox"/> YES	47.55	<input type="checkbox"/> NO <input checked="" type="checkbox"/> YES	79.0
$F \leq 50.15$ Hz	50.30	>120	<input checked="" type="checkbox"/> NO <input type="checkbox"/> YES	50.10	<input type="checkbox"/> NO <input checked="" type="checkbox"/> YES	78.0

In addition to this requirement, it has been verified that according to the point 7.7 of the standard, the Control System of the inverter has a function to start connection following a Defaults Ramp Rate. In this case, the adjusted gradient has been set as increasing rate of 16.7 %Pn per minute.

Frequency Connection Value Limit	Gradient (ΔP) desired (%P _n /min)	Gradient measured (%P _n /min)
F \geq 47.50 Hz	\leq 100.0%	16.9%
F \leq 50.15 Hz	\leq 100.0%	16.9%

Note: it has been considered a minimum delay of 60 seconds to proceed with the start-up once the equipment is inside the required ranges.

Test results are graphically shown in following pages.

Underfrequency Connection

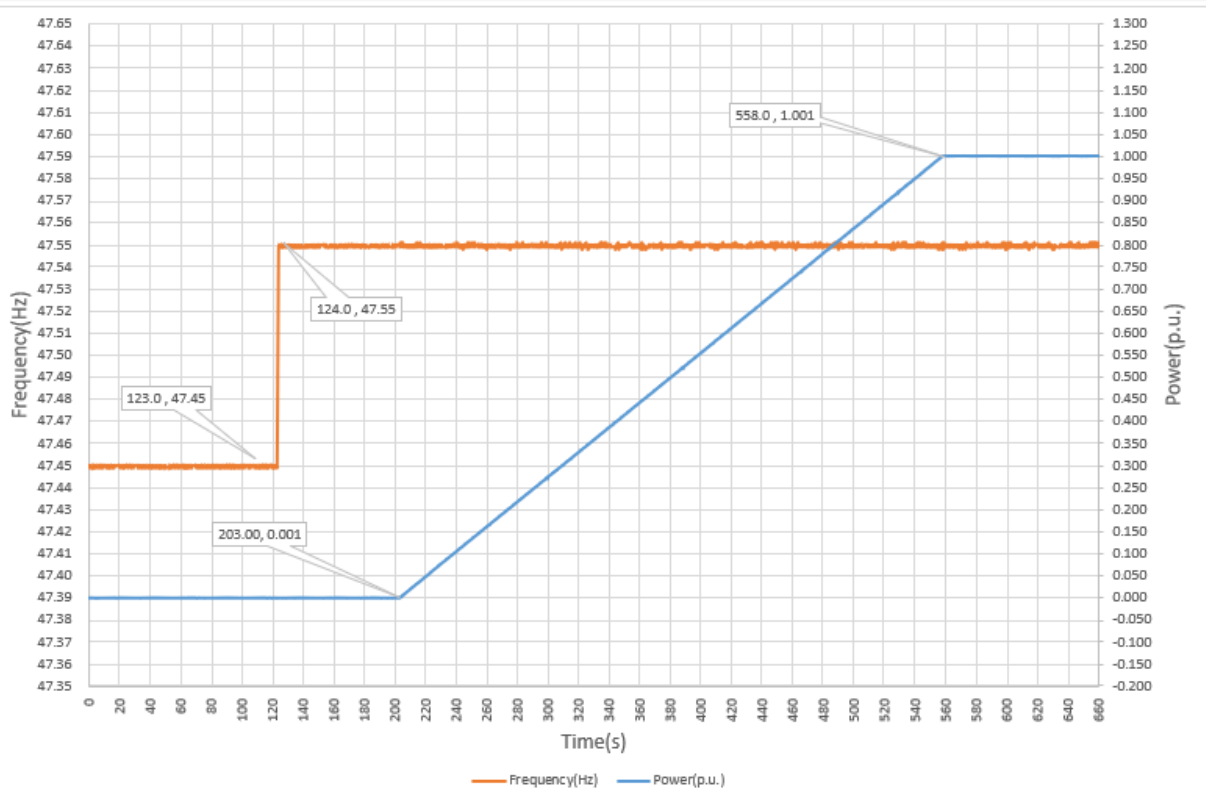

Overfrequency Connection

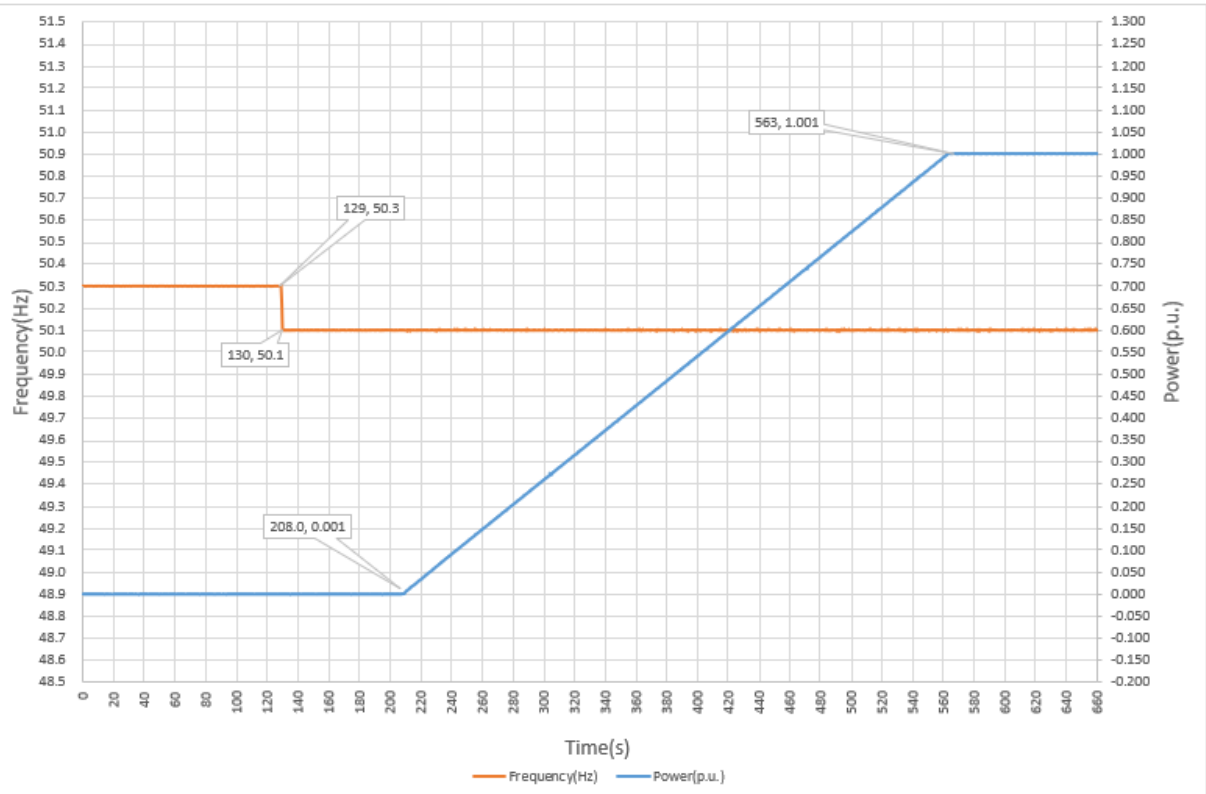

4.22.2 Frequency Reconnection

Test results are offered in the following tables:

Frequency Reconnection Value Limit	No Reconnection Test			Reconnection Test		
	Frequency value (Hz)	Time measured (s)	Reconnection	Frequency value (Hz)	Reconnection	Time measured (s)
F ≥ 47.50 Hz	47.40	>120	<input checked="" type="checkbox"/> NO <input type="checkbox"/> YES	50.00	<input type="checkbox"/> NO <input checked="" type="checkbox"/> YES	78.5
F ≤ 50.15 Hz	50.25	>120	<input checked="" type="checkbox"/> NO <input type="checkbox"/> YES	50.10	<input type="checkbox"/> NO <input checked="" type="checkbox"/> YES	78.0

In addition to this requirement, it has been verified that according to the point 7.7 of the standard, the Control System of the inverter has a function to start connection following a Defaults Ramp Rate. In this case, the adjusted gradient has been an increasing rate of 16.7 %P_n per minute.

Frequency Reconnection Value Limit	Gradient (ΔP) desired (%P _n /min)	Gradient measured (%P _n /min)
F ≥ 47.50 Hz	≤ 100.0%	17.0%
F ≤ 50.15 Hz	≤ 100.0%	16.9%

Note: it has been considered a minimum delay of 60 seconds to proceed with the start-up once the equipment is inside the required ranges.

Test results are graphically shown in the following pages.

Underfrequency Reconnection

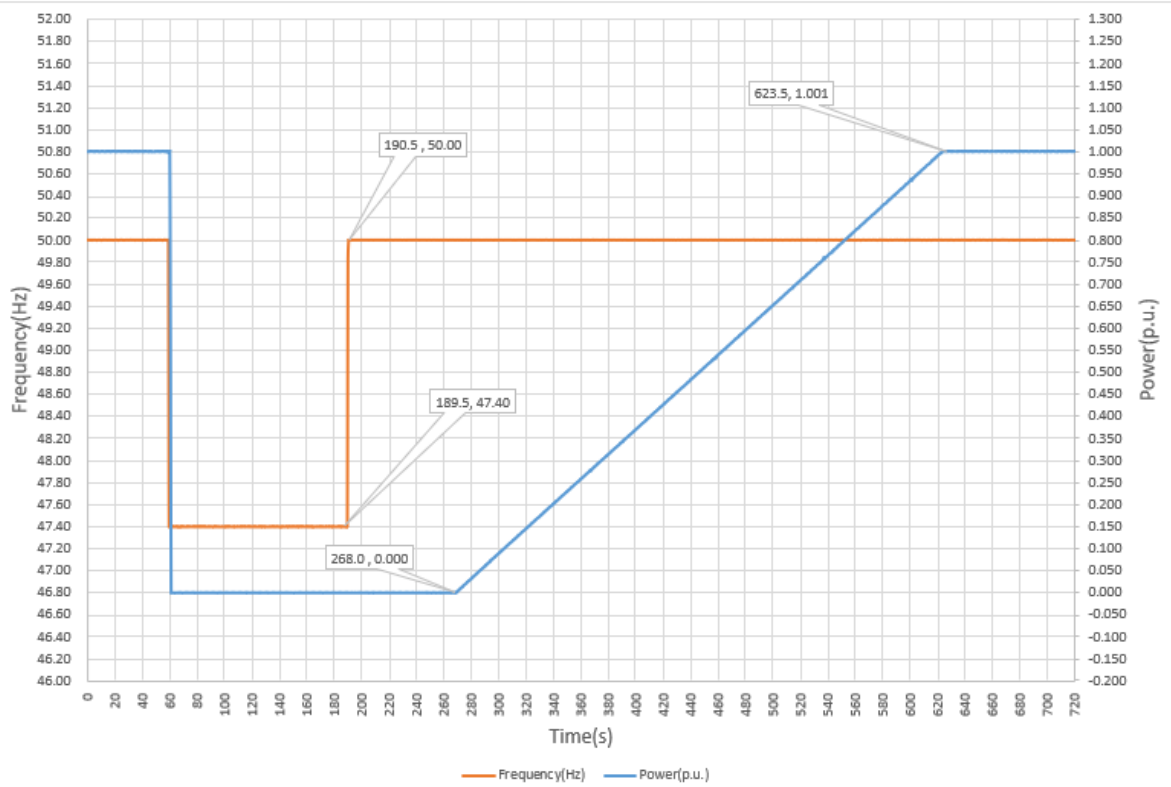

Overfrequency Reconnection

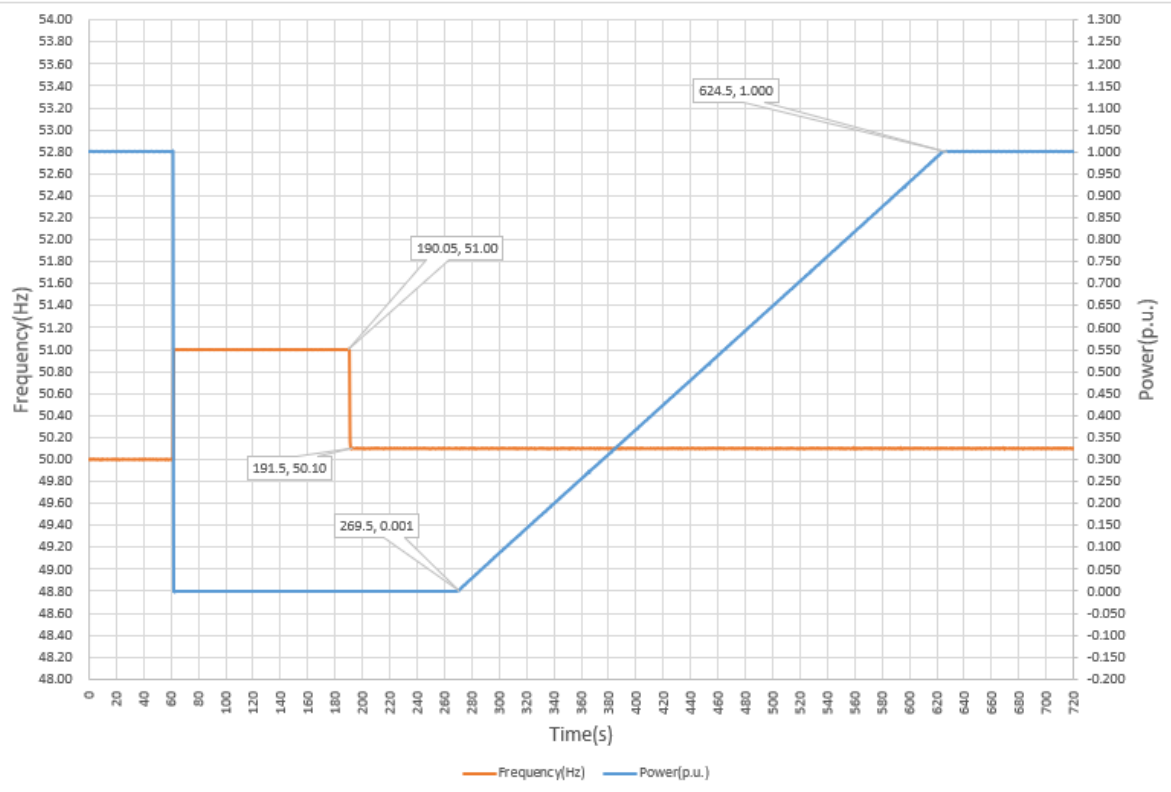

4.22.3 Voltage Connection

Test results are offered in the following tables:

Voltage Connection Value Limit	No Connection Test			Connection Test		
	Voltage value (%Un)	Time measured (s)	Connection	Voltage value (%Un)	Connection	Time measured (s)
$V \geq 94.0 \%U_n$	94.0%	>120	<input checked="" type="checkbox"/> NO <input type="checkbox"/> YES	94.7%	<input type="checkbox"/> NO <input checked="" type="checkbox"/> YES	78.5
$V \leq 110.0 \%U_n$	110.0%	>120	<input checked="" type="checkbox"/> NO <input type="checkbox"/> YES	109.0%	<input type="checkbox"/> NO <input checked="" type="checkbox"/> YES	74.5

The standard states that the tolerance limit for voltage connection values is $\pm 2 V$, which is a 0,8 %Un over 230 V, the reference voltage considered by the standard. So, 0.8 %Un is the allowed tolerance to be considered for voltage connection value tests.

In addition to this requirement, it has been verified that according to the point 7.7 of the standard, the Control System of the inverter has a function to start reconnection following a Defaults Ramp Rate. The following table shows the programmed gradient for the reconnections:

Voltage Connection Value Limit	Gradient (ΔP) desired (%P _n /min)	Gradient measured (%P _n /min)
$V \geq 94.0 \%U_n$	$\leq 100.0\%$	16.8%
$V \leq 110.0 \%U_n$	$\leq 100.0\%$	17.0%

Note: it has been considered a minimum delay of 60 seconds to proceed with the start-up once the equipment is inside the required ranges.

Test results are graphically shown in the following pages.

Undervoltage Connection

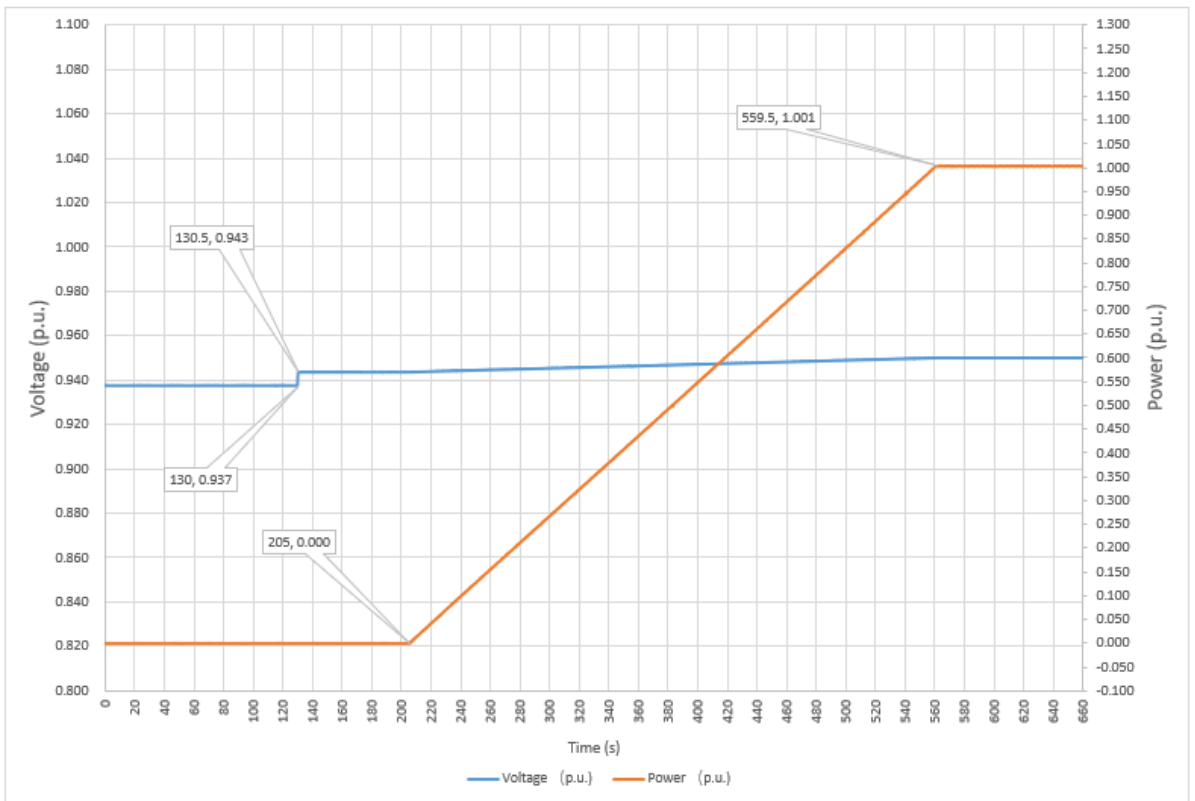

Overvoltage Connection

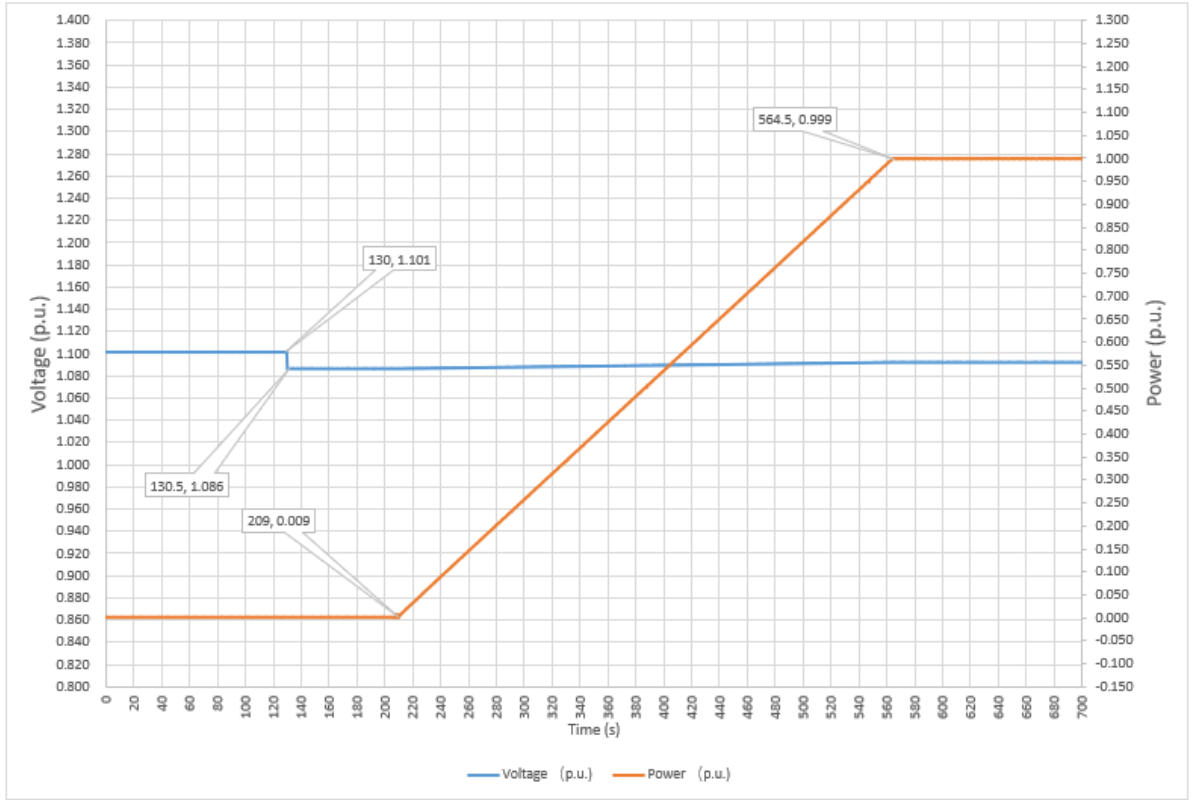

4.22.4 Voltage Reconnection

Test results are offered in the following tables:

Voltage Reconnection Value Limit	No Reconnection Test			Reconnection Test		
	Voltage value (%Un)	Time measured (s)	Reconnection	Voltage value (%Un)	Reconnection	Time measured (s)
$V \geq 94.0\% \text{Un}$	94.0%	>120	<input checked="" type="checkbox"/> NO <input type="checkbox"/> YES	94.7%	<input type="checkbox"/> NO <input checked="" type="checkbox"/> YES	78.0
$V \leq 110.0\% \text{Un}$	110.0%	>120	<input checked="" type="checkbox"/> NO <input type="checkbox"/> YES	109.0%	<input type="checkbox"/> NO <input checked="" type="checkbox"/> YES	78.5

The standard states that the tolerance limit for voltage reconnection values is $\pm 2\text{ V}$, which is a $0,8\% \text{Un}$ over 230 V , the reference voltage considered by the standard. So, $0,8\% \text{Un}$ is the allowed tolerance to be considered for voltage reconnection value tests.

In addition to this requirement, it has been verified that according to the point 7.7 of the standard, the Control System of the inverter has a function to start reconnection following a Defaults Ramp Rate. The following table shows the programmed gradient for the reconnections:

Voltage Reconnection Value Limit	Gradient (ΔP) desired (% P_n /min)	Gradient measured (P_n /min)
$V \geq 94.0\% \text{Un}$	$\leq 100.0\%$	16.9%
$V \leq 110.0\% \text{Un}$	$\leq 100.0\%$	16.9%

Note: it has been considered a minimum delay of 60 seconds to proceed with the start-up once the equipment is inside the required ranges.

Test results are graphically shown in the following pages.

Undervoltage Reconnection

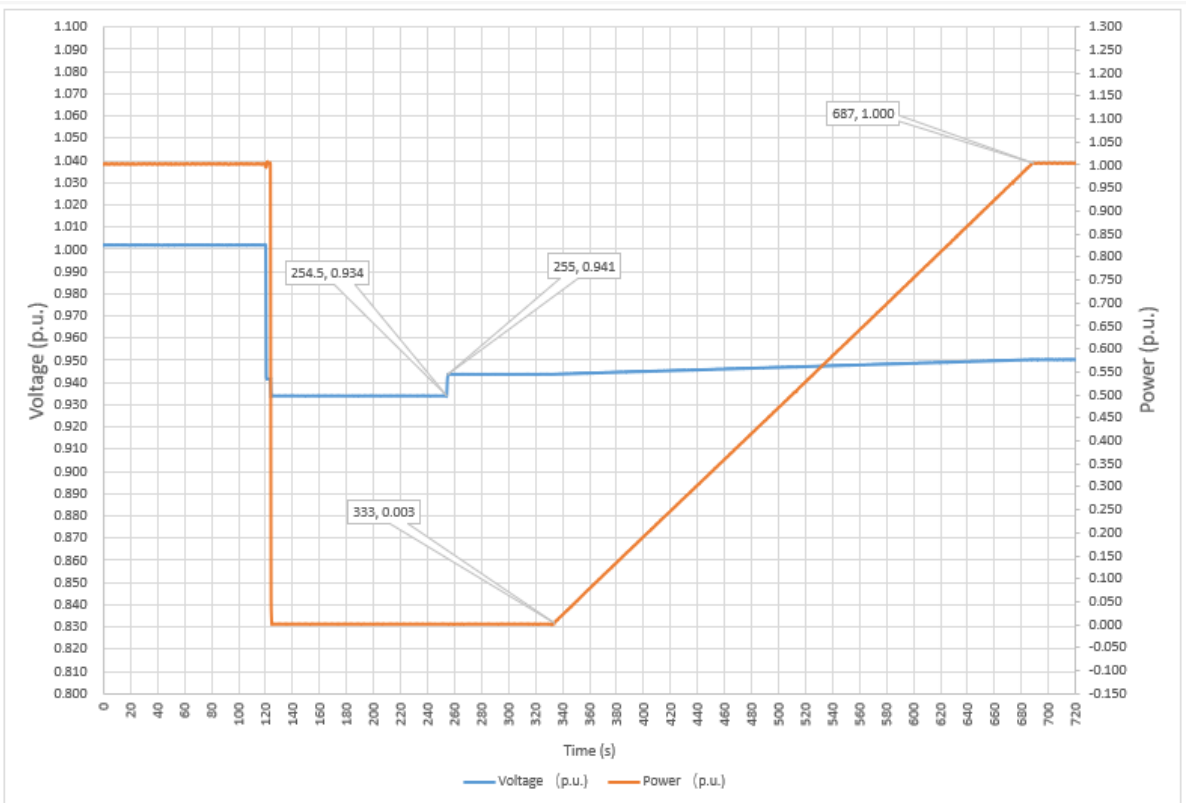

Overvoltage Reconnection

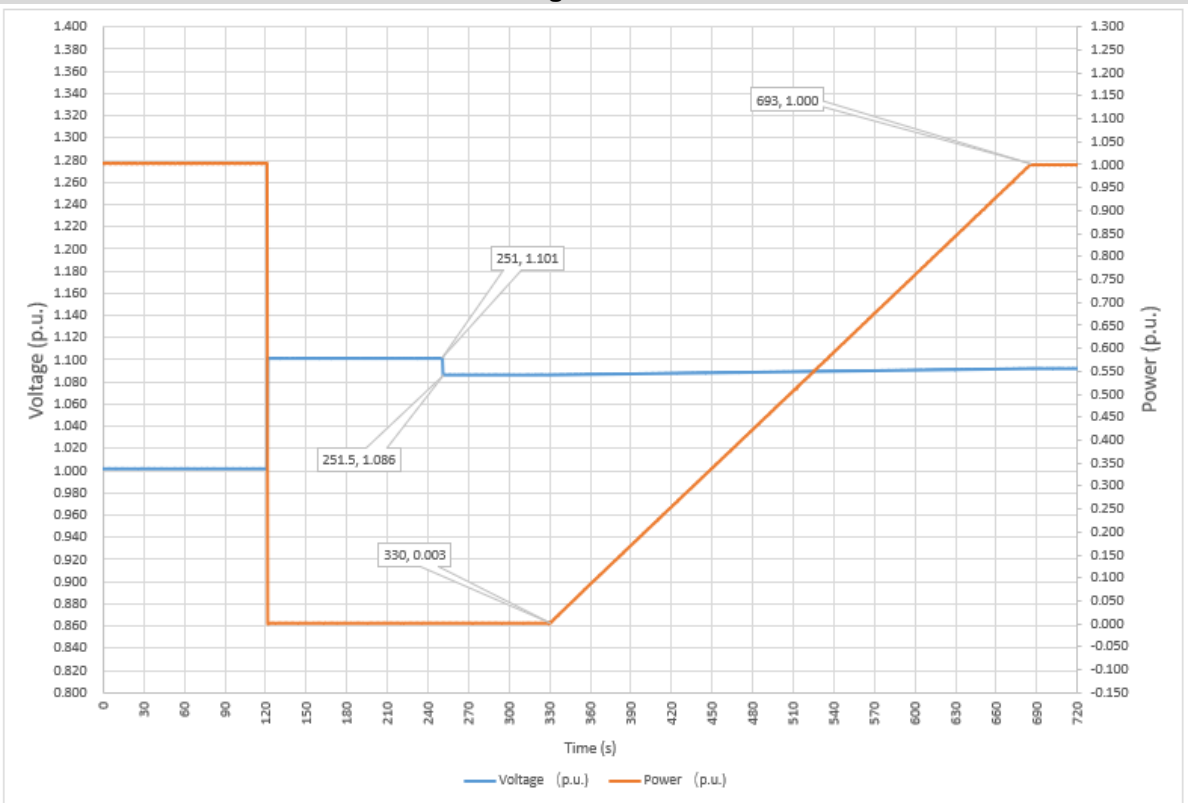

4.23 SECURITY OF PROTECTION SETTINGS

The inverter complies with the following requirements according to Clause 7.8 of the standard:

- a) The inverter has been checked by inspection that changes to the internal setting shall require the use of a tool and special instructions not provided to unauthorized personnel.
- b) The installer-accessible settings of the automatic disconnection device are capable of being adjusted within the limits specified in Clause 7.5 of the standard.
- c) The manufacturer settings of the automatic disconnection device, specified in Clause 7.4 of the standard, are secured against changes.

4.24 MULTIPLE INVERTER COMBINATION

According to the clause 8 of the standard, Inverter energy systems are often comprised of multiple inverters used in combination to provide the desired inverter energy capacity or to ensure that voltage balance is maintained in multiple phase connections to the grid.

Possible combinations could be single-phase inverters used in parallel, single-phase inverters used in multiple phase systems.

The inverter under testing doesn't have any of these functions incorporated in his control system, so this point is not applicable.

4.25 INVERTER MARKING AND DOCUMENTATION

The inverter is in compliance with marking and documentation requirements of IEC 62109-1, IEC 62109-2, and Clause 9 according AS/NZS 4777.2:2015.

- IEC 62109-1 and IEC 62109-2: test report n° BL-SZ1930579-B02 on 2019/04/20 which issued by Shenzhen BALUN Technology Co., Ltd.

According to points 9.2.4 and 9.2.5 the unit shall be marked with the following external or auxiliary systems if those are required to comply with the requirements from the standard:

External equipment requirement	Required (Yes or No?)
Isolation transformer	No
RCD / earth fault detection	No
External automatic disconnecter (DRM0)	No
External device to enable extra DRM modes	No

AS/NZS 4777.2:2015			
Clause	Requirement - Test	Result - Remark	Verdict
9	INVERTER MARKING AND DOCUMENTATION		P
9.1	General		P
	The inverter shall comply with the marking and documentation requirements of IEC 62109-1 and IEC 62109-2, as varied by this Clause (9).		P
	All markings and documentation shall be in the English language.		P
9.2	Marking		P
9.2.1	General		P

AS/NZS 4777.2:2015			
Clause	Requirement - Test	Result - Remark	Verdict
	The following variations apply to the marking requirements of IEC 62109-1 and IEC 62109-2:		P
	(a) Inverters that are designated for use in inverter energy systems incorporating energy sources other than PV arrays or batteries shall bear additional or alternative markings appropriate to the energy source.		P
	(b) Inverters that are designated for use in closed electrical operating areas shall be marked with a warning stating that they are not suitable for installation in households or areas of a similar type or use (i.e. domestic).	Not used in closed electrical operating areas.	N/A
9.2.2	Equipment ratings		P
	The inverter shall be marked with its ratings and the ratings of each port, as specified in Table 15. Only those ratings that are applicable to the type of inverter are required. The ratings shall be plainly and permanently marked on the inverter, in a location that is clearly visible after installation.		P
9.2.3	Ports		P
	Each port shall be marked with its classification and indicate whether a.c or d.c. voltage as appropriate.		P
	Typical classifications include the following:		P
	(a) PV (photovoltaic).		P
	(b) Wind turbine.		N/A
	(c) Energy storage.		N/A
	(d) Battery.		N/A
	(e) Generator.		N/A
	(f) Grid-interactive.		P
	(g) Stand-alone.		N/A
	(h) Communications (type).		P
	(i) DRM.		P
	(j) Load.		P
9.2.4	External and ancillary equipment		N/A
	If the inverter requires external or ancillary equipment for compliance with this Standard, the requirement for any such equipment shall be marked on the inverter along with the following or an equivalent statement: 'Refer to the installation instructions for type and ratings' or symbol.		N/A
	Any external or ancillary equipment shall be marked in accordance with this Clause (9).		N/A
9.2.5	Residual current devices (RCDs)		P
	Inverter energy systems used with PV array systems require residual current detection in accordance with IEC 62109-1 and IEC 62109-2. The requirements can be met by the installation of a suitably rated RCD external to	An RCMU integral to the inverter used	P

AS/NZS 4777.2:2015			
Clause	Requirement - Test	Result - Remark	Verdict
	the inverter or by an RCMU integral to the inverter.		
	Where an external RCD is required, the inverter shall be marked with a warning along with the rating and type of RCD required. The warning shall be located in a prominent position and written in lettering at least 5 mm high. It shall contain the following or an equivalent statement:		N/A
	WARNING: AN RCD IS REQUIRED ON THE [NAME] PORTS OF THE INVERTER		N/A
	If the inverter energy system requires a Type B RCD, the inverter shall be marked with a warning. The warning shall be located in a prominent position and written in lettering at least 5 mm high. It shall contain the following:		N/A
	WARNING: A TYPE B RCD IS REQUIRED ON THE [NAME] PORTS OF THE INVERTER		N/A
9.2.6	Demand response modes		P
	The demand response modes supported by the inverter should be permanently marked on the name plate or on a durable sticker located on or near the demand response interface port to indicate the demand response modes of which the unit is capable.	DRM 0	P
	Figure 9 illustrates an acceptable form of marking. If this form of marking is used, each box shall contain a tick or a cross (if the inverter has that capability) or remain blank (if it does not have that capability). Alternatively, only the modes supported may be marked.		P
	If the physical interface is a terminal block, then—	Terminal block used	P
	(a) the terminals shall be engraved or otherwise durably marked; or		P
	(b) a permanent label with 'DRM Port' shall be affixed near the terminal block.		P
	The marking shall indicate which terminal corresponds to which demand response mode.		P
	The range of markings is indicated against Pins 1 to 6 in Table 7.	DRM 0	P
9.3	Documentation		P
9.3.1	General		P
	The documentation supplied with the inverter shall provide all information necessary for the correct installation, operation and use of the system and any required external devices including information specified in Clause 9.2.		P
	All inverters, including those intended for use in systems incorporating energy sources other than PV arrays or batteries, shall comply with the documentation requirements of IEC 62109-1 and IEC 62109-2.		P
9.3.2	Equipment ratings		P

AS/NZS 4777.2:2015			
Clause	Requirement - Test	Result - Remark	Verdict
	The documentation supplied with the inverter shall state the ratings of the inverter and the ratings for each port, as specified in Table 16. Only those ratings that are applicable to the type of inverter are required.		P
	For equipment with rated current greater than 16 A per phase, additional documentation requirements apply. See Clause 5.7.		P
9.3.3	Ports		P
	In addition to the requirements of Clause 9.3.2, the documentation supplied with the inverter shall state the following for each port, as a minimum:		P
	(a) Means of connection.		P
	(b) For pluggable equipment type B, the type of matching connectors to be used.		P
	(c) External controls and protection requirements.		P
	(d) Explanation of terminals or pins used for connection including polarity and voltage.		P
	(e) Tightening torque to be applied to terminals.		N/A
	(f) Instructions for protective earthing.		P
	(g) Instructions for connection of loads and installation of RCD protection to stand-alone ports.		N/A
	(h) The decisive voltage class (DVC).		P
9.3.4	External and ancillary equipment		N/A
	Where an inverter or multiple inverter combinations requires external or ancillary equipment for compliance with this Standard, the documentation shall—		N/A
	(a) state the requirement for any such equipment;		N/A
	(b) provide sufficient information to identify the external or ancillary equipment, either by manufacturer and part number or by type and rating; and		N/A
	(c) specify assembly, location, mounting and connection requirements.		N/A
9.3.5	RCDs		N/A
	Where an external RCD is required, the following or an equivalent statement shall be included in the documentation: 'External RCD Required'. The documentation shall also state the rating and type of RCD required and provide instructions for the installation of the RCD.	An RCMU integral to the inverter used	N/A
9.3.6	Multiple mode inverters	Not Multiple mode inverters	N/A
	Where the inverter is capable of multiple mode operation, the documentation shall include the following:		N/A

AS/NZS 4777.2:2015			
Clause	Requirement - Test	Result - Remark	Verdict
	(a) Ratings and means of connection to each source of supply to the inverter or output from the inverter.		N/A
	(b) Any requirements related to wiring and external controls, including the method of maintaining neutral continuity within the electrical installation to any stand-alone ports as required.		N/A
	(c) Disconnection means and isolation means.		N/A
	(d) Overcurrent protection needed.		N/A
9.3.7	Multiple inverter combinations	No in such used	N/A
	Where an inverter has been tested for use in a multiple inverter combination as per Clause 8, the documentation shall include the following:		N/A
	(a) Valid combinations of inverters.		N/A
	(b) Installation instructions for correct operation as a multiple inverter combination.		N/A

5 PICTURES

Front view 1 (SOFAR 2700TL-G3, SOFAR 3000TL-G3, SOFAR 3300TL-G3)



Back view 1 (SOFAR 2700TL-G3, SOFAR 3000TL-G3, SOFAR 3300TL-G3)

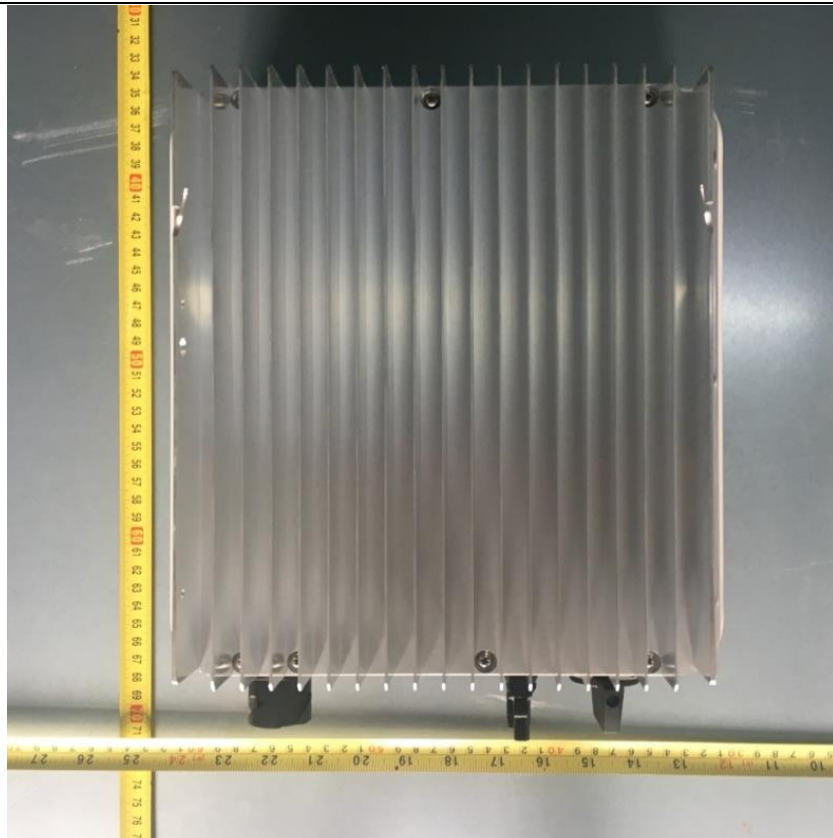

Front view 2 (SOFAR 1100TL-G3, SOFAR 1600TL-G3, SOFAR 2200TL-G3)



Back view 2 (SOFAR 1100TL-G3, SOFAR 1600TL-G3, SOFAR 2200TL-G3)

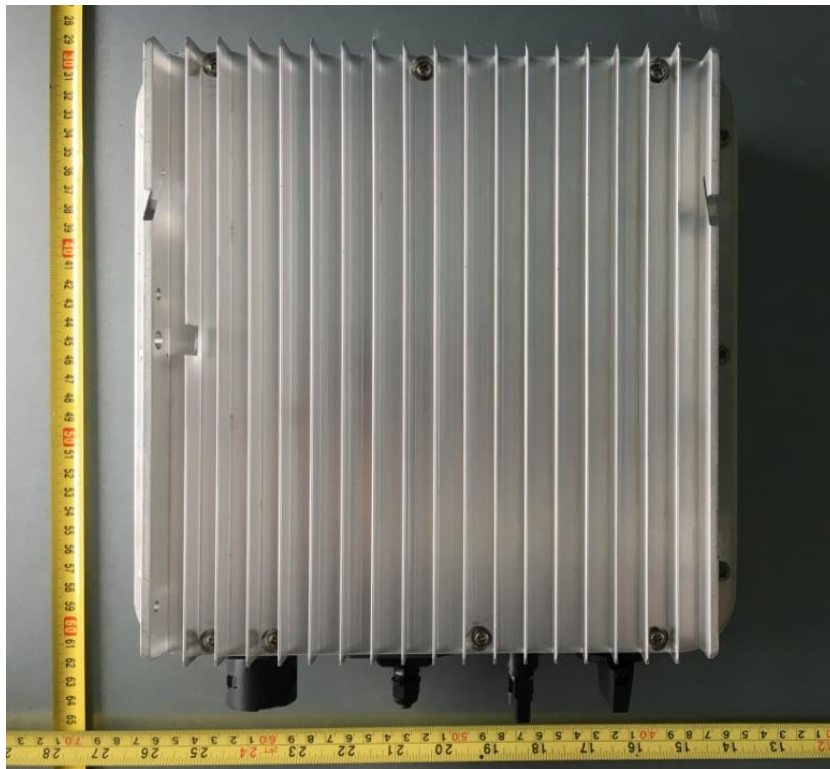

Side View (SOFAR 2700TL-G3, SOFAR 3000TL-G3, SOFAR 3300TL-G3)



Side View (SOFAR 1100TL-G3, SOFAR 1600TL-G3, SOFAR 2200TL-G3)

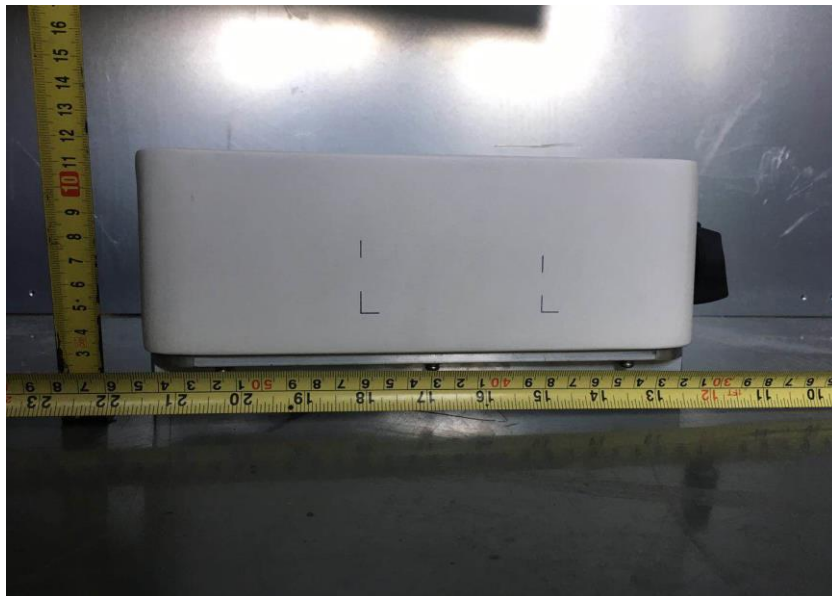

Internal view of enclosure (SOFAR 2700TL-G3, SOFAR 3000TL-G3, SOFAR 3300TL-G3)

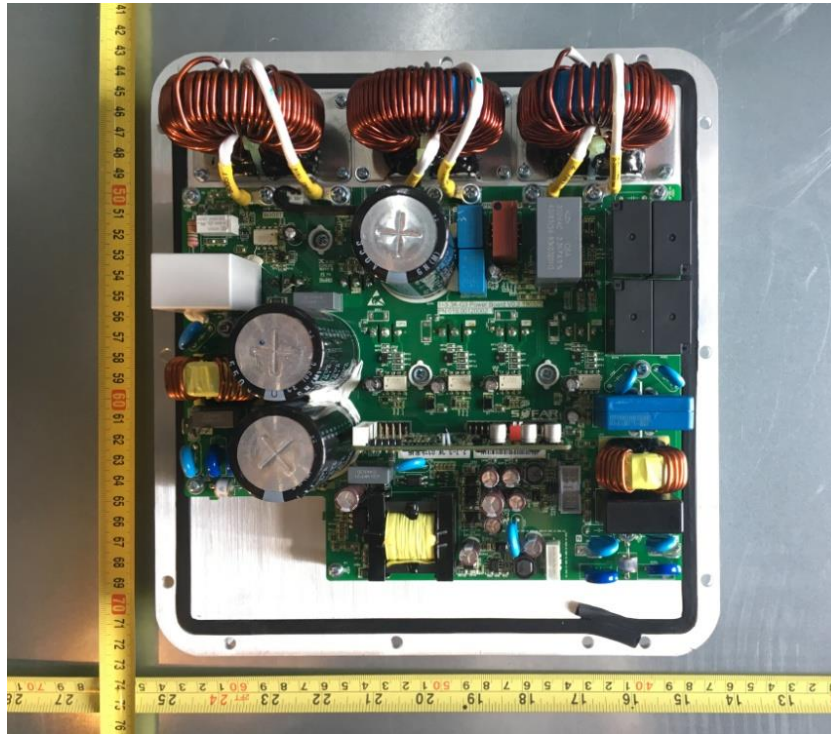

Internal view of enclosure (SOFAR 1100TL-G3, SOFAR 1600TL-G3, SOFAR 2200TL-G3)

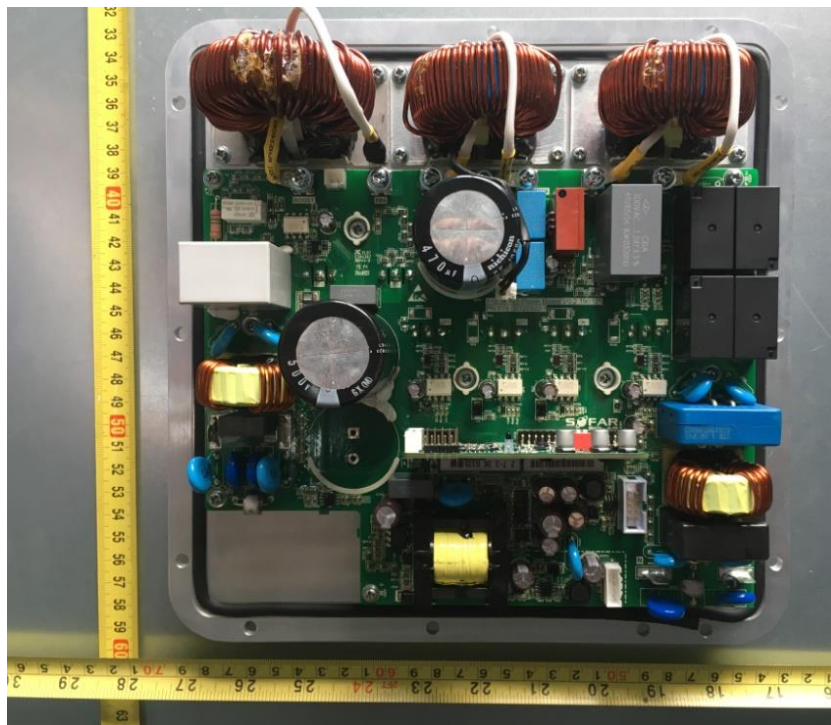

Front side of main board 1 (SOFAR 2700TL-G3, SOFAR 3000TL-G3, SOFAR 3300TL-G3)

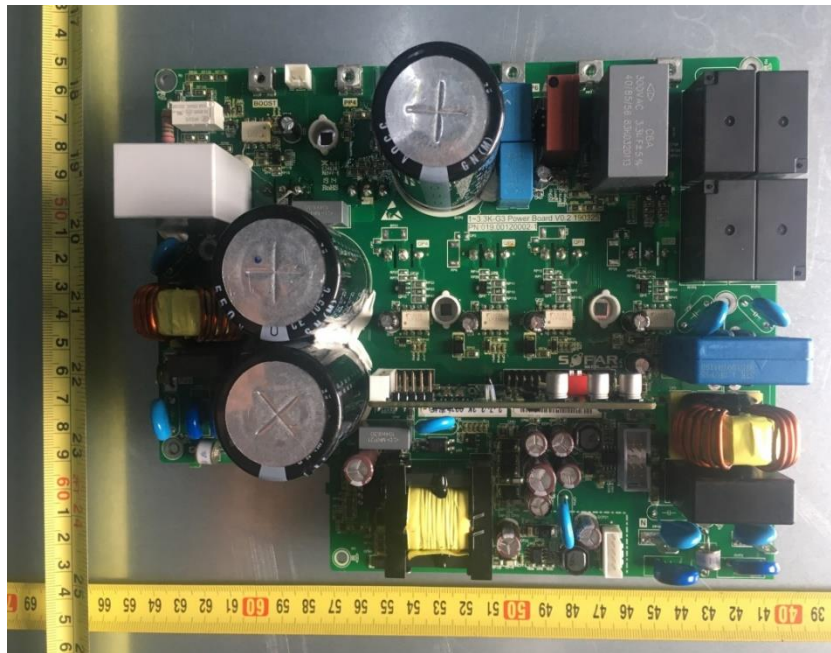

Back side of main board 1 (SOFAR 2700TL-G3, SOFAR 3000TL-G3, SOFAR 3300TL-G3)

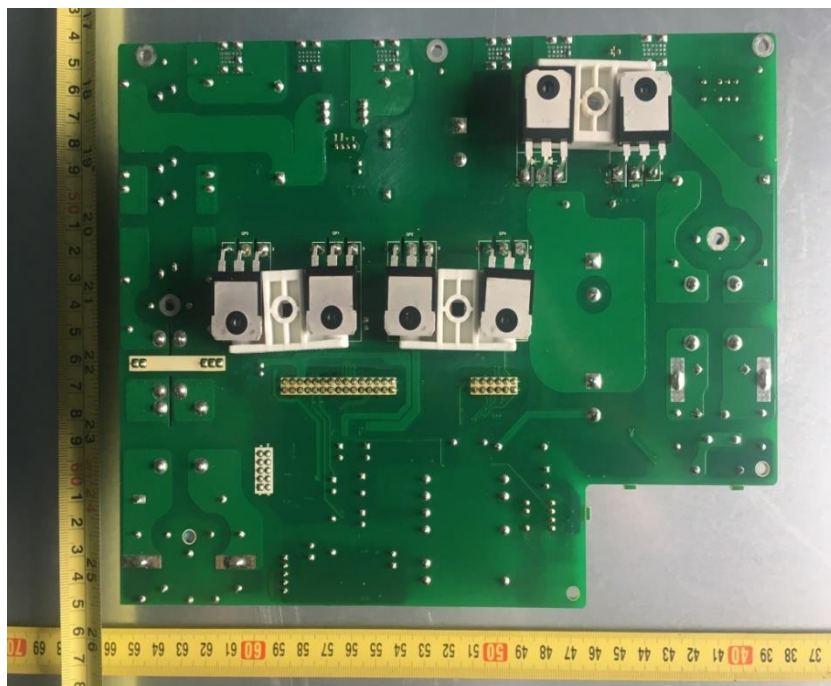

Front side of main board 2 (SOFAR 1100TL-G3, SOFAR 1600TL-G3, SOFAR 2200TL-G3)

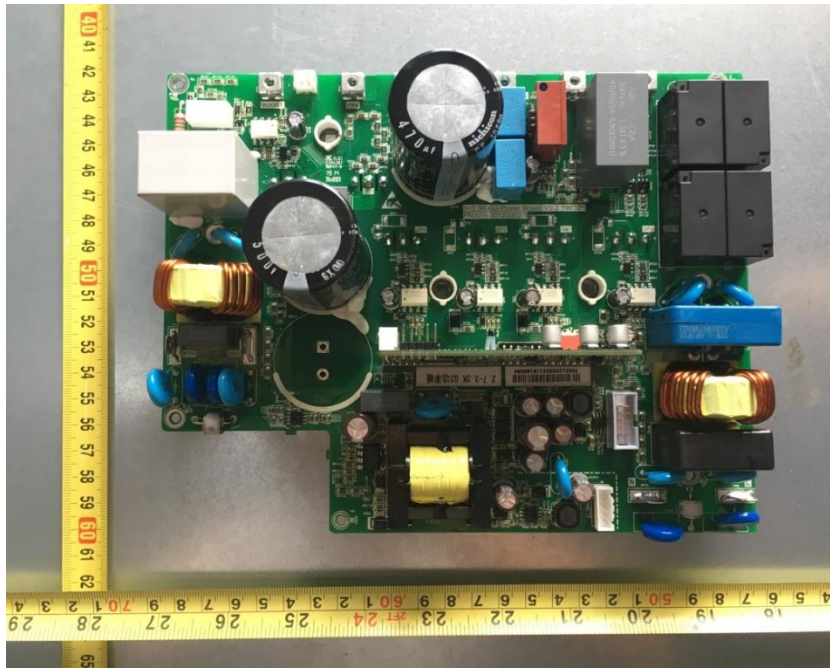

Back side of main board 2 (SOFAR 1100TL-G3, SOFAR 1600TL-G3, SOFAR 2200TL-G3)

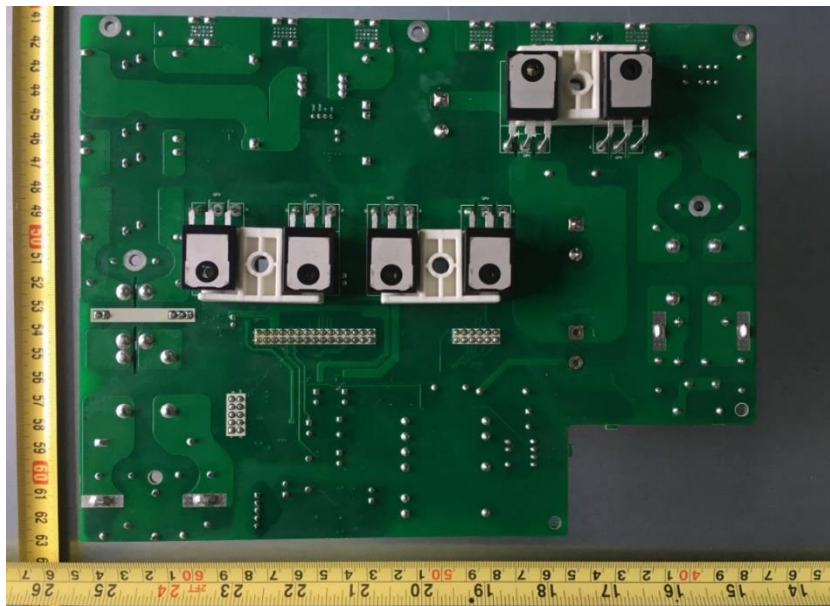

Front side of Control board

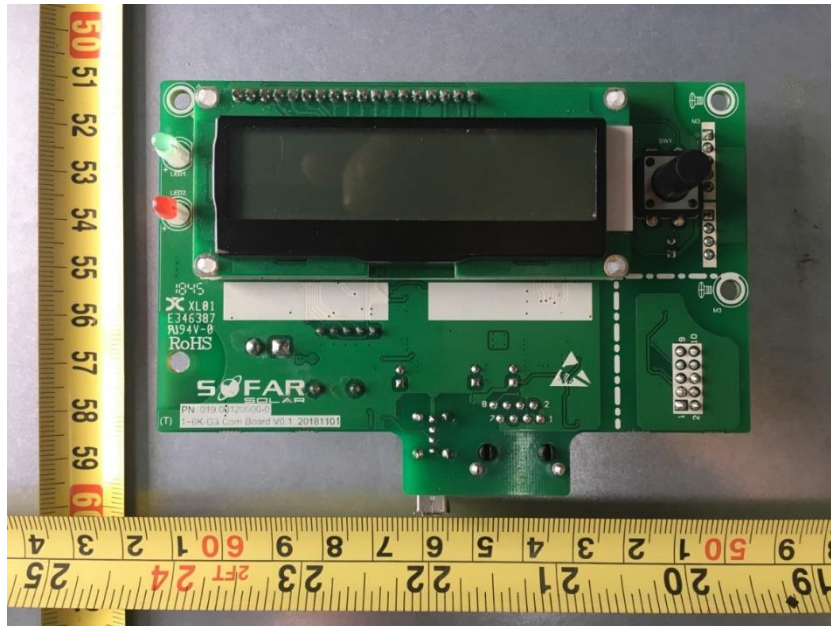

Front side of Control board

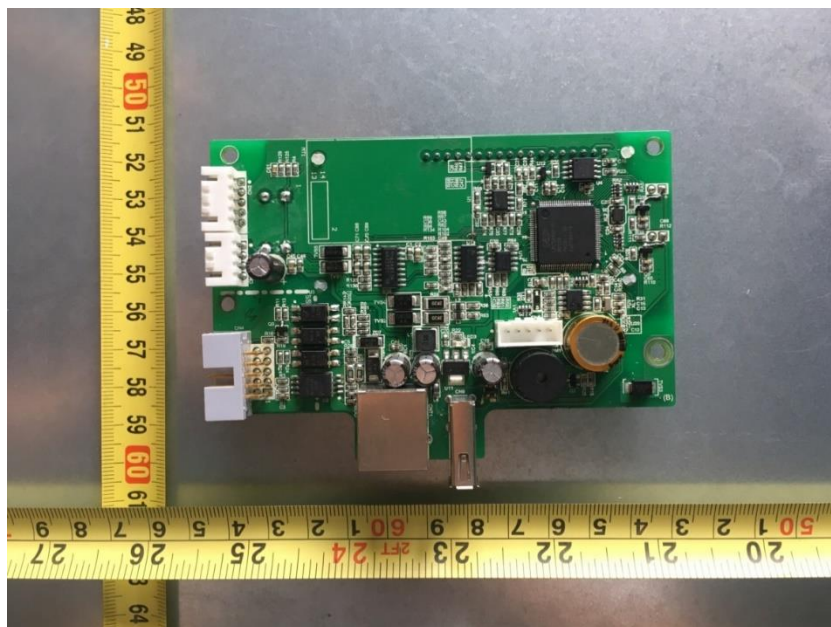

Front view of RS 232 board

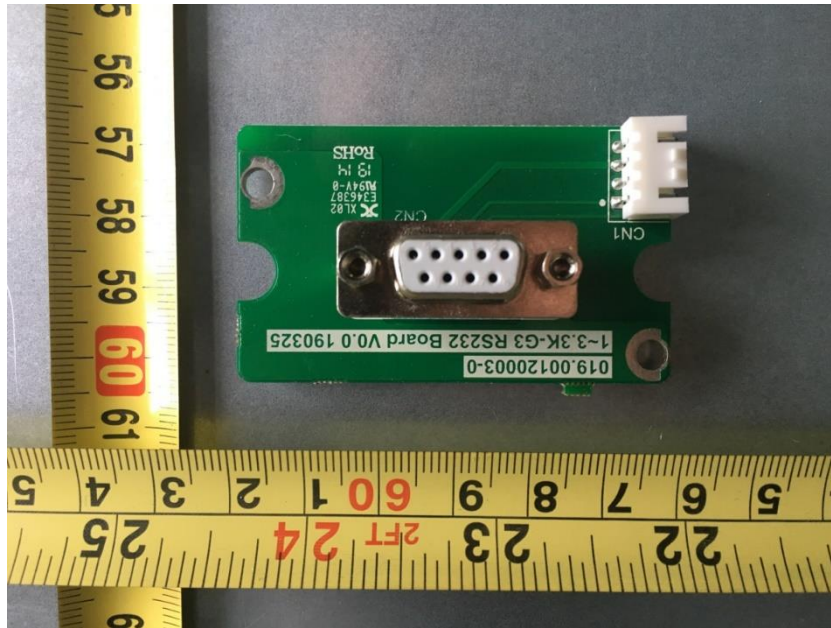

Back view of RS 232 board

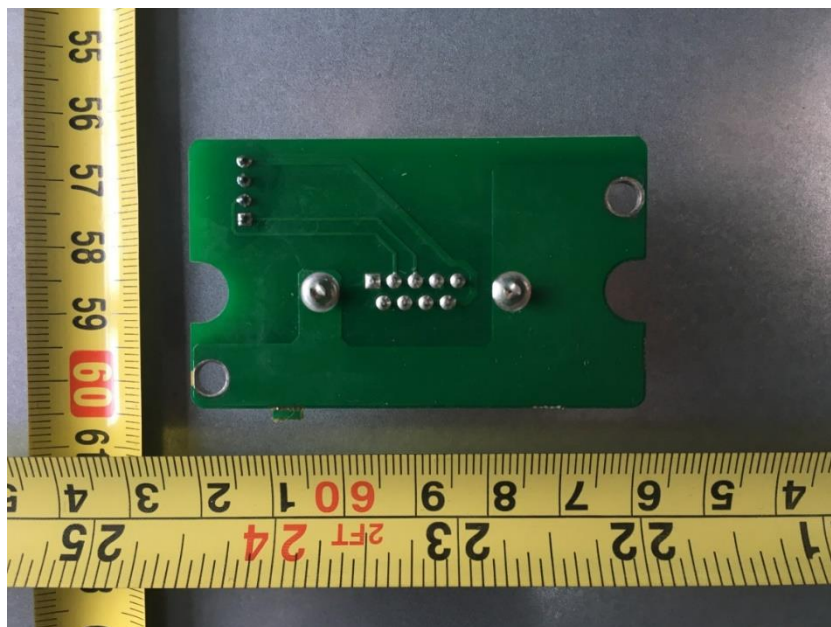

Connection interface



Grounding

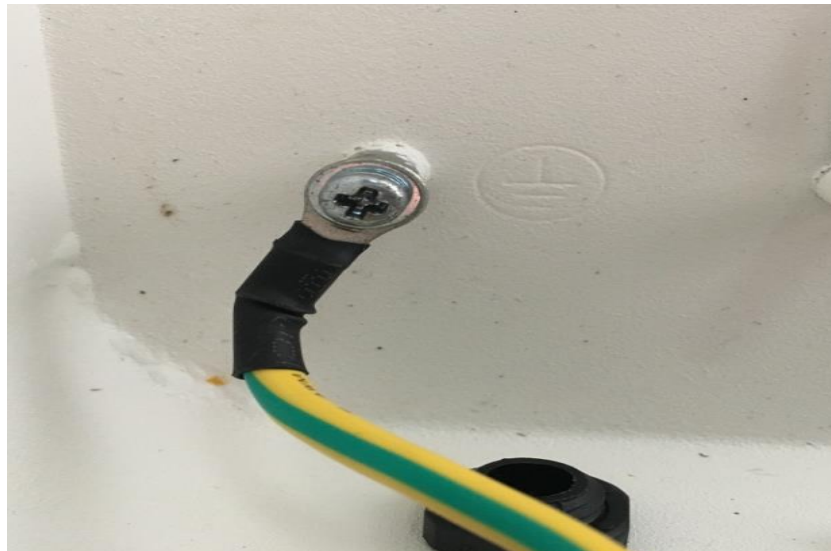

AS/NZS 4777.2:2015.

Software Number

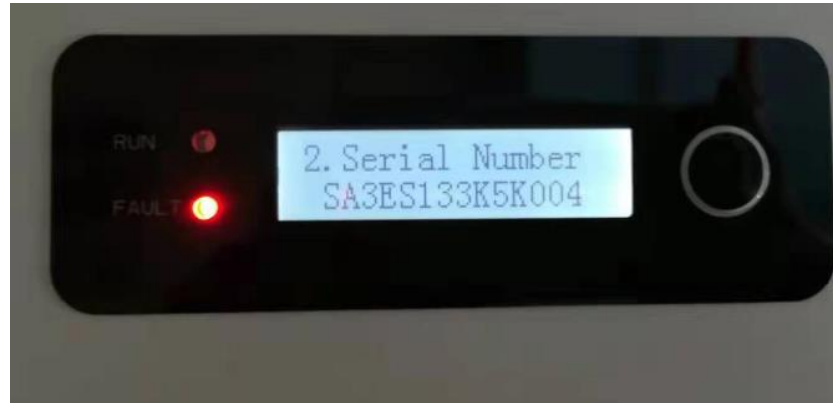

Software version



6 ELECTRICAL SCHEMES

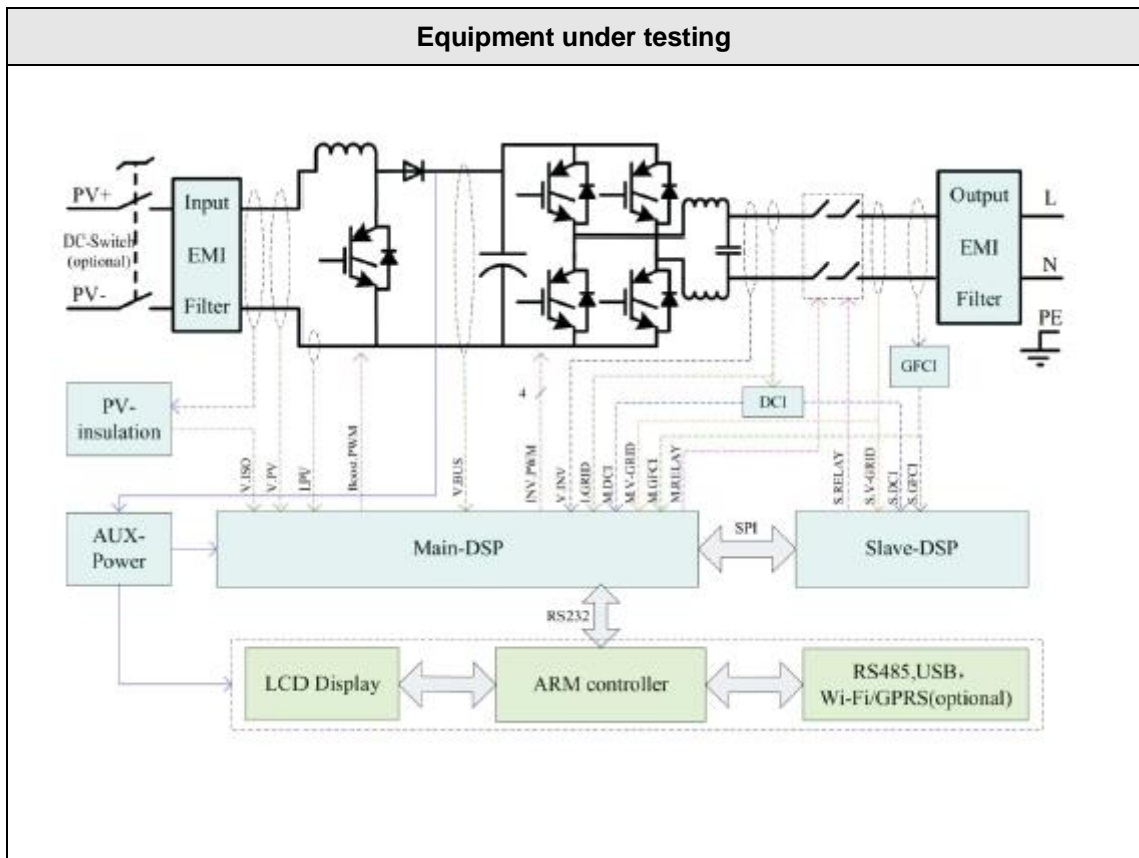

-----END OF REPORT-----